

CATALOGO COPERTURE MOBILI

MOVABLE COVERINGS CATALOGUE
KATALOG: ÜBERDACHUNGSSYSTEME
CATALOGUE COUVERTURES MOBILES



inTenda[®]
www.intenda.it





BOX MODULARE



Il Box Modulare è l'ideale per coprire la vostra automobile, piccola o media, utilizzando un rapido e pratico sistema di apertura e chiusura a chiocciola.





Box Modulare is the best choice to cover your car, even if it is a wagon or SUV. It is equipped with a fast opening/closing system made as a snail.



Die Box Modulare ist die ideale Lösung, um kleine oder mittlere Wagen zu schützen. Die Box Modulare hat die Form einer Schnecke und lässt sich sehr einfach öffnen und schließen.



Le Box Modulare est la solution idéale pour couvrir votre voiture, petite ou grande, en utilisant le rapide et pratique système d'ouverture et fermeture à escargot.



JAGUAR E-type V12 - anno 1973 | MASERATI 3500 GT - anno 1962
 Museo Nicolis - Villafranca di Verona

BOX TUNNEL



Il Box Tunnel è la soluzione ideale per chi dispone di poco spazio e intende sfruttarlo al meglio. Una volta richiuso su se stesso, infatti, la superficie di ingombro è minima.





The Box Tunnel is the ideal solution for those who have little space and would like to employ it to its full potential. Once closed, in fact, the overall dimension is minimal.



Die Box Tunnel ist die ideale Lösung für diejenigen, die wenig Platz haben und möchten es am besten benutzen. Einmal komplett zusammengeschoben, ist die Grundfläche minimal.



Le Box Tunnel est la solution idéale pour ceux qui ont peu d'espace et entendent l'exploiter au maximum. Une fois fermé, en fait, l'encombrement est minime.



MASERATI 3500 GT - anno 1962
Museo Nicolis - Villafranca di Verona

DUAL BOX



Dual Box è il prodotto ideale per la copertura di due automezzi affiancati. Indicato anche come rimessaggio o per applicazioni industriali (camere di verniciatura, essiccazione, ecc...).





Dual Box is designed to cover two cars placed side by side. This box is also a good choice to cover industrial machines.



Die Dual Box ist entwickelt worden, um zwei Wagen nebeneinander zu überdachen. Sie wird daher gern auch im Industriebereich (Lackkabine, Trockenraum, usw) eingesetzt.



Dual Box est le produit idéal pour couvrir deux voitures cote à cote. Il est même indiqué comme couverture industrielle (par exemple comme chambre pour le laquage ou pour le séchage).



AUSTIN HEAVY 12/4 TAXI CAB - anno 1937
Museo Nicolis - Villafranca di Verona

CARAVAN BOX



Caravan Box è il prodotto ideale per la copertura dei camper, progettato per veicoli di altezza e lunghezza straordinari. Le sue misure permettono di coprire anche i camper più grandi, lasciando un ampio spazio di manovra.





Caravan Box is designed to cover caravans. It can also cover very high vehicles leaving enough space to maneuver.



Die Caravan Box ist für die Überdachung von Wohnwagen und Wohnmobilen geeignet. Übermaße werden berücksichtigt, um damit auch größere Fahrzeuge und Wagen schützen zu können



Caravan Box est le produit idéal pour la couverture des camping-cars. Ses mesures permettent de couvrir même les camping-cars plus grands en ayant quand-même un large espace de manœuvre.



MAXI BOX



Maxi Box è la copertura che raggiunge dimensioni molto ampie, e si presta quindi a diversi utilizzi: da copertura per piccoli autocarri e furgoni a deposito per attrezzi o rimessaggio.





Thanks to its big dimensions, Maxi box can be used for different purposes: as a cover for small trucks and vans, as a small warehouse or for storage.



Die Maxi Box ist die Überdachung, die sehr große Ausmaße erreicht. Deshalb eignet sie sich für verschiedene Anwendungen: als Abdeckung für Kleinlaster und Lieferwagen oder Lager für Werkzeuge.



Maxi Box est la couverture qui rejoint des dimensions très grands, et qui se prête donc à différents usages: couverture pour petits camions et camionnettes, stockage d'outils ou entrepôt.



BOX ZOPPO



Disponibile nelle versioni a 1 e a 2 falde, il Box zoppo è progettato per essere addossato ad una parete. E' particolarmente indicato per lo stoccaggio di merci, garantendo il minimo spreco di spazio.





Available in 2 versions, 1 and 2 pitches, the Intenda Box Zoppo is designed to be placed against a wall. It is particularly suitable for the storage of goods, ensuring the minimal waste of space.



Erhältlich in 2 Versionen, Sattel- und Pultdach, die Intenda Box Zoppo wurde entwickelt, um gegen eine Wand gestellt zu werden. Sie eignet sich besonders für die Lagerung von Waren, und sie erlaubt viel Platz zu sparen.



Disponible en 2 versions, à 1 et 2 versants, le Box Zoppo Intenda est conçu pour être placé contre un mur. Il est particulièrement adapté pour le stockage de marchandises, en assurant le minimum de déchets de l'espace.



CARGO BOX



Il Cargo Box è il nostro box mobile più grande, adatto a coperture di dimensioni eccezionali: magazzini, zone di carico e scarico merci, cantieri navali, depositi attrezzature e automezzi.





Cargo Box is our biggest movable cover, and can be used as warehouse, goods load/unload area and shipyard.



Die Cargo Box ist die Intenda größte Box, die speziell für LKWs und Sonderfahrzeuge entwickelt wurde.



Le Cargo Box est le Box Intenda le plus grand. Il est la solution idéale pour couvrir des camions ou véhicules spéciaux.



STADIO BOX



Stadio Box è il prodotto ideato per la copertura di superfici molto lunghe, come ad esempio le uscite dagli spogliatoi negli stadi e nei palazzetti dello sport, oppure come collegamento tra stabilimenti, tensostrutture, capannoni.





Stadio Box is designed to be a long cover, used mainly to cover the players exits in the stadia, or as a link between two buildings.



Stadio Box ist als Verbindungstunnel konzipiert worden. Sie wird beispielsweise in Stadien eingesetzt - wenn Spieler auf das Feld kommen - oder als Verbindung zwischen Hallen oder Zelten.



Le Stadio Box est le produit le plus indiqué pour couvrir surfaces très longues, comme par exemple les sorties des vestiaires dans les stades et dans les palais des sports ou comme liaison entre bâtiments ou autres structures.



COPRIPISCINA



Il Copripiscina Intenda è un rivoluzionario sistema di copertura per piscine. È la soluzione ideale per proteggere la piscina da sporcizia e insetti o per permetterne l'utilizzo anche durante la stagione invernale.

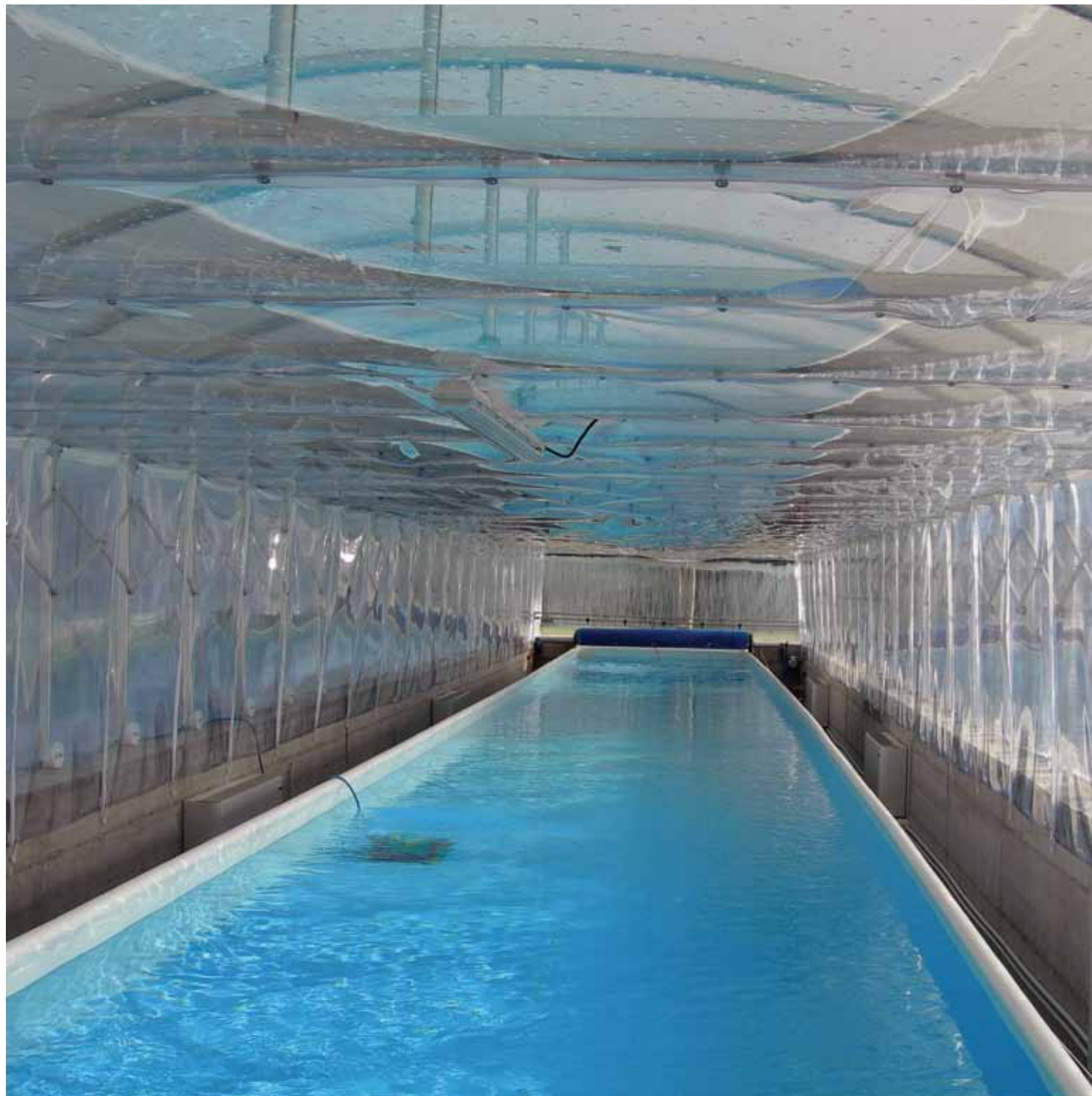



Copripiscina is a special cover for swimming pools. It is the ideal solution to protect the pool from dirt and bugs, and allows its use even during the cold season.



Die Intenda Copripiscina ist ein revolutionäres Überdachungssystem für Schwimmbäder. Sie wirkt als Schutz vor Schmutz und Insekten und erlaubt, das Schwimmbad auch in Winter auszunutzen.



Le Copripiscina Intenda est une révolutionnaire couverture pour piscines. Elle est la solution idéale pour protéger la piscine de la saleté et les insectes, et permet son utilisation pendant la saison hivernale.



PARETE MOBILE



La Parete Mobile è un prodotto progettato per la chiusura di grandi aperture o per la suddivisione degli spazi all'interno di magazzini e capannoni. Ideale anche come chiusura di una tettoia.





Parete Mobile can be used to split two working areas in a warehouse, or to close a shed transforming it into a comfortable garage.



Die Parete Mobile ist die ideale Lösung, um offene Gebäude zu schließen oder um eine Halle zu teilen. Man kann sie vollständig öffnen und schließen.



La Parete Mobile est un produit conçu pour fermer des couverture ouverte en les transformant dans des garages ou pour diviser des dépôts.



PORTA A STRISCE



La Porta a Strisce è il sistema più comodo ed economico per proteggere i vostri ambienti da polvere, umidità, caldo, freddo, rumore e insetti volanti, aumentando il comfort e la vivibilità.





Porta a strisce is the cheapest solution to protect goods and workers inside a warehouse. The special PVC stripes protects from humidity, hot, cold, noise and flying bugs.



Porta a strisce ist das bequeme und günstige System, um Ihre Räume vor Schmutz, Staub, Kälte, Wärme, Feuchtigkeit und fliegende Insekten zu schützen. Somit wird das Komfort und die Lebensqualität verbessert.



Porta a strisce est le système pratique et avantageux pour protéger vos locaux de poussière, froid, chaleur, humidité et insectes volants. Comme ça le confort et la qualité de vie améliorent.



CENTINA SCORREVOLE



Centina Scorrevole è la copertura mobile per rimorchi creata da Intenda. Leggera e funzionale, permette l'apertura e la chiusura in pochi secondi.





The movable cover for trailers is a light and functional product that can be fully opened and closed in a few seconds.



Die Intenda Anhängerüberdachung ist ein leichtes und funktionales Produkt, das vollständig und in wenigen Sekunden zusammengesoben und wieder aufgemacht werden kann



La Centina Scorrevole est la couverture mobile pour remorques qui est légère et fonctionnelle. Elle permet l'ouverture et fermeture du remorque en quelques seconds.



CENTINA SCORREVOLE AUTOCARRO



La Centina Scorrevole Autocarro è la copertura mobile ideale per autocarri. Permette di accedere con facilità e in pochi secondi al pianale.





Centina Scorrevole Autocarro is the ideal cover for trucks. It allows an easy access to the truck floor in a few seconds.



Centina Scorrevole Autocarro ist die ideale Überdachung für LKWs. Sie ermöglicht einen leichten und schnellen Zugang zu dem LKW-Boden.



Centina Scorrevole Autocarro est la couverture idéale pour les camions. Elle permet un accès facile et rapide au plancher du camion.



MOTOBOX



Il Motobox (disponibile in versione a chiocciola oppure a tunnel) è una copertura leggera per veicoli a due ruote (moto, ciclomotori, scooter).





The Motobox (available in the snail version and in the tunnel version) is a cover for two wheels vehicles (motorbikes, mopeds, scooters).



Die Motobox (verfügbar in der Schnecke- und Tunnel-Version) ist eine Abdeckung, die für Zwei-Räder-Fahrzeuge (Motorräder, Mopeds, Motorroller) gedacht wurde.



Le Motobox est disponible en deux versions (à escargot et à tunnel). Il est une couverture légère pour véhicules à deux roues (motos, vélomoteurs, scooters).



Piaggio Vespa 125 - anno 1948 | Harley Davidson XL 883 - anno 1989
Museo Nicolis - Villafranca di Verona

BOX MODULARE

MISURE DISPONIBILI

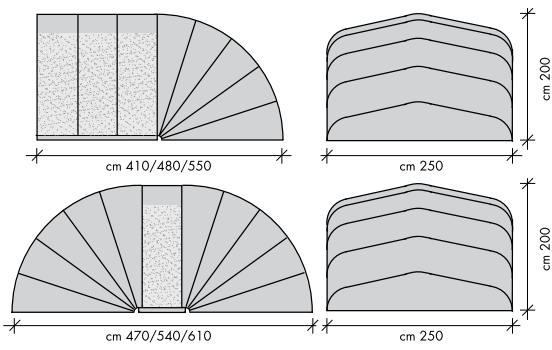

COLORI DISPONIBILI



BOX TUNNEL

MISURE DISPONIBILI

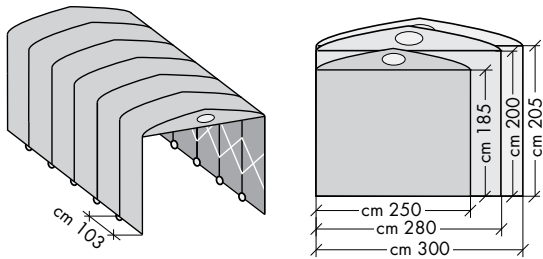

COLORI DISPONIBILI



DUAL BOX

MISURE DISPONIBILI

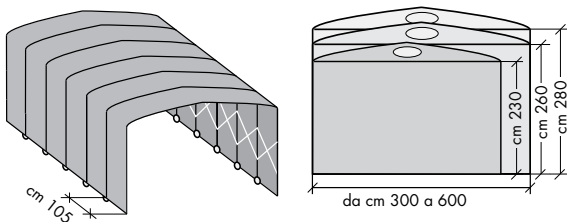

COLORI DISPONIBILI



CARAVAN BOX

MISURE DISPONIBILI

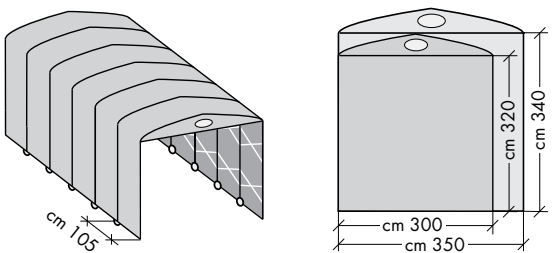

COLORI DISPONIBILI



MAXI BOX

MISURE DISPONIBILI

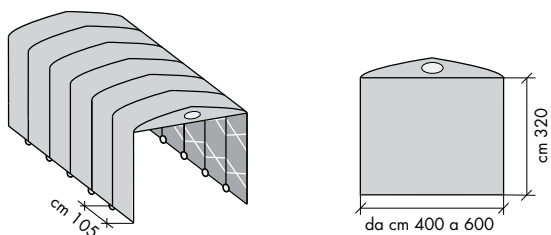

COLORI DISPONIBILI



BOX ZOPPO

MISURE DISPONIBILI

1 FALDA

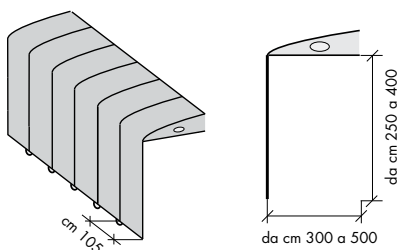

2 FALDE

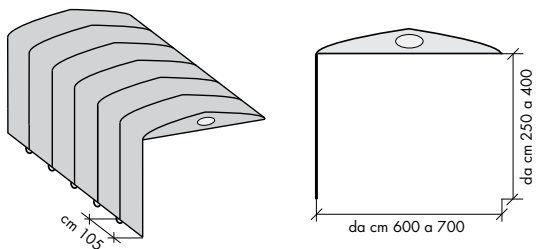

COLORI DISPONIBILI



CARGO BOX

MISURE DISPONIBILI

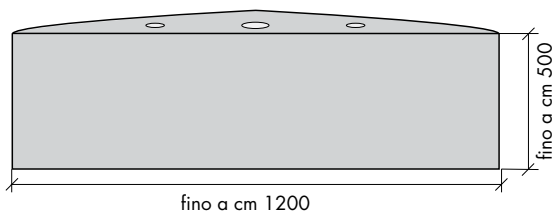

COLORI DISPONIBILI



STADIO BOX

MISURE DISPONIBILI

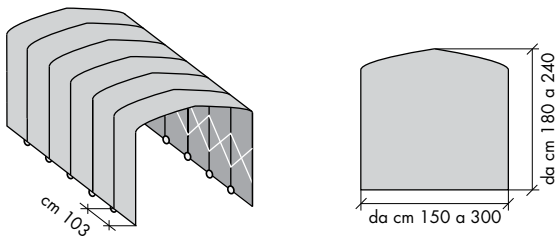

COLORI DISPONIBILI



COPRIPISCINA

MISURE DISPONIBILI

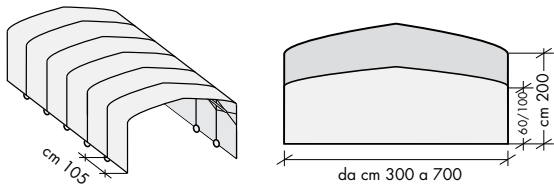

COLORI DISPONIBILI



Il Copripiscina viene solitamente realizzato con il tetto in tinta unita (colore a scelta, consigliato il bianco), e con i laterali trasparenti per facilitare l'irraggiamento solare.

PARETE MOBILE

MISURE DISPONIBILI

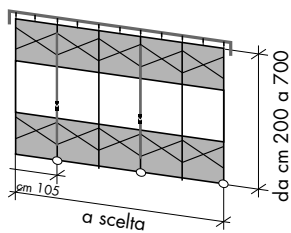

COLORI DISPONIBILI

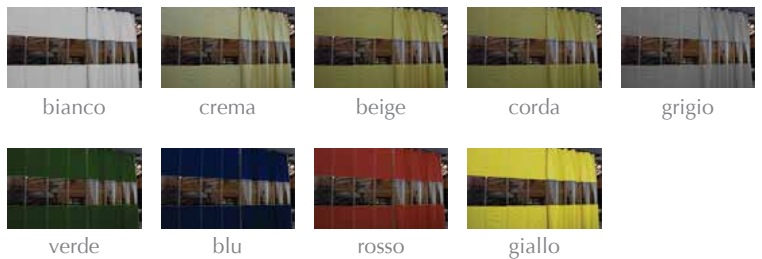

PORTA A STRISCE

MISURE DISPONIBILI

La porta a strisce viene fornita a misura, non ci sono limiti di larghezza o di altezza.

Le strisce "Standard", "Rinforzate" e "Basse temperature" sono di serie trasparenti.

Sono disponibili strisce di mm 200 x 2 nei colori a lato. N.B.: i colori stampati sono solo indicativi

COLORI DISPONIBILI



CENTINA SCORREVOLE + CENTINA SCORREVOLE AUTOCARRO

MISURE DISPONIBILI

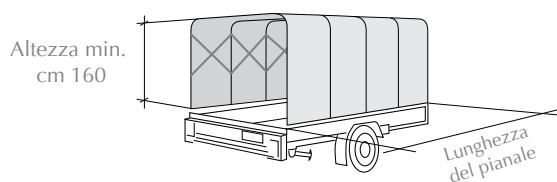

COLORI DISPONIBILI



MOTOBOX A TUNNEL

MISURE DISPONIBILI

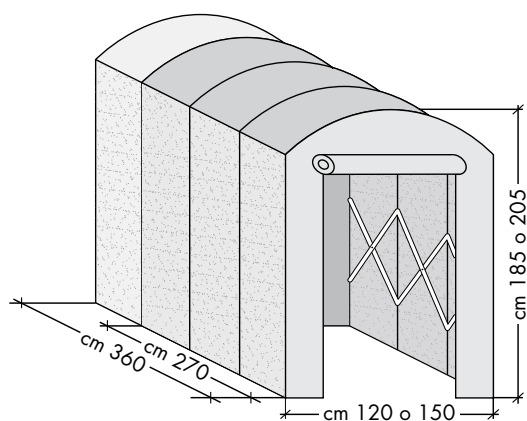

COLORI DISPONIBILI

PVC OPACO

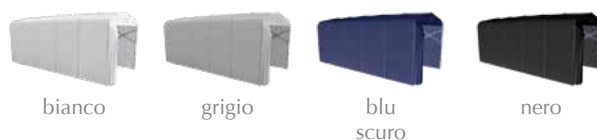

MOTOBOX A CHIOCCIOLA

MISURE DISPONIBILI

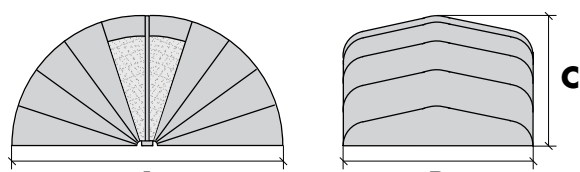

A	B	C
280	130	140
320	130	160
360	140	180

COLORI DISPONIBILI

PVC OPACO





MUSEO NICOLIS
DELL' AUTO · DELLA TECNICA · DELLA MECCANICA



**CULTURA, DIVERTIMENTO, INCONTRI E SPERIMENTAZIONI:
AL MUSEO NICOLIS DI VILLAFRANCA. LE SORPRENDENTI
TESTIMONIANZE DELLA SOCIETÀ CONTEMPORANEA.**

7 COLLEZIONI E CENTINAIA DI PEZZI UNICI

Creato da Luciano Nicolis, imprenditore veronese e grande collezionista che ha fatto confluire in questa modernissima struttura (6.000 mq) la sua passione per la tecnica e la meccanica, il "Museo Nicolis dell'Auto, della Tecnica e della Meccanica" di Villafranca è uno dei più importanti Musei privati italiani, è stato aperto al pubblico sin dalla sua inaugurazione, nel 2000, e rappresenta uno dei principali poli di attrazione dell'intero territorio veronese, in grado di offrire a visitatori italiani e stranieri un formidabile mix di cultura, divertimento, sorprese e innovazione. I "numeri" delle 7 collezioni sono importanti: 100 auto d'epoca, 120 biciclette, 105 moto, 500 macchine fotografiche, 120 strumenti musicali, 100 macchine per scrivere, piccoli velivoli e centinaia di opere dell'ingegno umano sono esposti secondo percorsi storici e stilistici; all'area espositiva si affiancano il Centro Congressi, l'archivio storico, la biblioteca e un Bookshop fra i più forniti del Norditalia sul mondo dei motori.



**KULTUR, UNTERHALTUNG, MEETINGS UND EXPERIMENTE: MUSEO
NICOLIS IN VILLAFRANCA. DIE ERSTAUNLICHE ZEUGNISSE DER
ZEITGENÖSSISCHEN GESELLSCHAFT.**

7 SAMMLUNGEN UND HUNDERTE EINZIGARTIGER STÜCKE

Museo Nicolis wurde von Luciano Nicolis, Unternehmer aus Verona und großer Sammler erstellt, der seine Leidenschaft für Technik und Mechanik in diesem modernen Gebäude (6.000 Quadratmeter) eingegangen ist. Das „Museo Nicolis dell'Auto, della Tecnica e della Meccanica“ in Villafranca ist ein der wichtigsten italienischen privaten Museen und wurde der Öffentlichkeit seit seiner Eröffnung im Jahr 2000 eröffnet und ist eine der Hauptattraktionen des gesamten Territoriums von Verona. Es bietet italienische und ausländische Besucher eine beeindruckende Mischung aus Kultur, Unterhaltung, Überraschungen und Innovationen. Die "Zahlen" der 7 Sammlungen sind wichtig: 100 Oldtimer, 120 Fahrräder, 105 Motorräder, 500 Kameras, 120 Musikinstrumente, 100 Schreibmaschinen, kleine Flugzeuge und Hunderte von Werken des menschlichen Geists sind nach historischen und stilistischen Vorlagen gezeigt. Neben der Ausstellung sind das Konferenzzentrum, den historischen Archiv, die Bibliothek und ein Bookshop zu finden. Dieses Bookshop ist ein der besser über die Welt des Motorsports ausgestattet im Norditalien.



**CULTURE, ENTERTAINMENT, MEETINGS AND EXPERIMENTATION:
MUSEO NICOLIS OF VILLAFRANCA. THE AMAZING TESTIMONIES OF
CONTEMPORARY SOCIETY.**

7 COLLECTIONS AND HUNDREDS OF UNIQUE PIECES

Created by Luciano Nicolis, Verona entrepreneur and a great collector who gathered into this modern building (6.000 sqm) his passion for technology and mechanics, "Nicolis Museum of, Technology and Mechanics" of Villafranca is one of the most important Italian private museum. It was opened to the public since its inauguration in 2000, and is one of the main attractions of the entire territory of Verona, offering to Italian and foreign visitors a great mix of culture, entertainment, surprises and innovation. The "numbers" of the seven collections are important: 100 vintage cars, 120 bikes, 105 motorcycles, 500 cameras, 120 musical instruments, 100 typewriters, small planes and hundreds of works of the human intelligence are exhibited according to historical and stylistic patterns. Near the stand area there are the conference center, the historical archive, the library and one of the richest Bookshops of Northern Italy concerning motors world.



**CULTURE, LOISIRS, RENCONTRES ET EXPÉRIMENTATIONS: LE MUSEO
NICOLIS DE VILLAFRANCA. LES TÉMOIGNAGES ÉTONNANTS DE LA
SOCIÉTÉ CONTEMPORAINE.**

7 COLLECTIONS ET DES CENTAINES DE PIÈCES UNIQUES

Créé par Luciano Nicolis, entrepreneur de Vérone et grand collectionneur, qui a fait entrer dans ce bâtiment moderne (6.000 mètres carrés) sa passion pour la technologie et la mécanique, le "Museo Nicolis dell'Auto, della Tecnica e della Meccanica" à Villafranca est l'un des musées privés italiens les plus importants. Il a été ouvert au public depuis son inauguration en 2000, et il est l'une des attractions principales de l'ensemble du territoire de Vérone, offrant aux visiteurs italiens et étrangers un mélange formidable de culture, divertissement, surprises et innovations. Les «numéros» des 7 collections sont important: 100 voitures d'époque, 120 vélos, 105 motos, 500 caméras, 120 instruments de musique, 100 machines à écrire, des petits avions et des centaines d'œuvres de l'intelligence humaine sont présentés selon des modèles historiques et de style. A côté de l'exposition on trouve le Centre de Conférence, l'archive historique, la bibliothèque et l'un des bookshop les plus fournis dans le nord de l'Italie pour ce qui concerne le monde des moteurs.

PER SAPERNE DI PIÙ - UM MEHR DARÜBER ZU ERFAHREN
POUR EN SAVOIR PLUS - FOR FURTHER INFORMATION



MUSEO NICOLIS
DELL' AUTO · DELLA TECNICA · DELLA MECCANICA

www.museonicolis.com

via Postumia - Villafranca di Verona • tel 045 6303289 - 045 6304959
dalle 10 alle 18 - chiuso il lunedì







INTENDA SRL
37045 S. PIETRO DI LEGNAGO (VR)
VIA V. PARETO, 3
TEL +39 0442 601031 - 600270
FAX +39 0442 25164
<http://www.intenda.it> - e-mail: info@intenda.it