

1974-2014

40

years



scolaro®

SAIL PARASOL

04. Vela

RETRATTILI/RETRACTABLES

06. Galileo White

08. Galileo Dark

10. Galileo Maxi 4x4

BRACCIO/SIDE POST

12. Giotto Braccio

14. Milano Braccio

16. Leonardo Braccio

18. Palladio Braccio

20. Napoli Braccio

22. Rimini Braccio

24. Torino Braccio

STANDARD

26. Milano Standard

28. Napoli Standard

30. Palladio Standard

TELESCOPIC

32. Leonardo Telescopico

34. Palladio Telescopico

36. Capri

GRANDI COPERTURE/SPECIAL STRUCTURES

38. Milano Poker/Double

40. Alu Poker/Double

42. Wood Poker/Double

44. BASI/BASES

48. SCHEDE TECNICHE/TECHNICAL SCHEDULES

66. MATERIALI E FINITURE/MATERIALS AND FINISHING

68. NEW SYSTEM

69. SOLE LIGHT

70. REFERENZE/REFERENCES



VERONA, Piazza delle Erbe - 1976



.Dimensione (metri)
 .Dimensions (meters)
 .Masse (Meter)
 .Dimensions (mètrès)
 .Dimensiones (en metros)
 .Afmeting in (meters)



.Stecche
 .Ribs
 .Streben
 .Baleines
 .Varillas
 .Baleinen



.Piastrre cemento
 .Cement slabs
 .Kiesbetonplatten
 .Dalles ciment
 .Planchas de cemento
 .Betontegel



.Viteria in inox e ottone nichelato
 .Screws in Stainless steel and nickel plated brass
 .Edelstahlschrauben und vernickeltes Messing
 .Visserie inox et laiton nickelé
 .Tornillos en acero inoxidable y bronce niquelado
 .Schroeven van rvs en vernikkeld messing



.Codice
 .Code
 .Artikelcode
 .Code
 .Código
 .Artikelcode



.Set canaline
 .Raingutter set
 .Regerinnen
 .Set gouttières
 .Canalizador Lluvias
 .Set regengoten



.Fodero
 .Cover bag
 .Schutzhuelle
 .Housse
 .Forro
 .Afdekhoes



.Tipo finitura della struttura/sostegno/componenti
 .Finishing for frame/structure/components
 .Ausführung des Gestells/der Struktur/der Bestandteile
 .Finition armature/structure/composants
 .Tipo de acabadò de la estructura/Soportes/componente

Pag. 66



.Lunghezza
 .Length
 .Laenge
 .Longueur
 .Longitud
 .Lengte



.Con base/supporo
 .With base/support
 .Mit Staender/Huelse
 .Avec base/support
 .Con base/ soporte
 .Inclusief standaard



.Doppia carrucola
 .Double pulley
 .Doppelter Seilzug
 .Double poulie
 .Doble polea
 .Dubbelle katrollen



.Colore dei componenti/stecche
 .Component/Ribs colour
 .Farbe der Bestandteile und Streben
 .Couleur des composants et baleines
 .Color de los componentes ò piezas/Varillas ò listones



.Peso
 .Weight
 .Gewicht
 .Poids
 .Peso
 .Gewicht

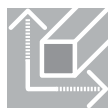

.Sezione stecche
 .Rib section
 .Strebenprofil
 .Section baleines
 .Sección varillas
 .Profiel baleinen



.Sistema telescopico
 .Telescopic system
 .Teleskopsystem
 .Système telescopique
 .Sistema telescópico
 .Telescoop systeem



.Stecca con sistema "easy change"
 .Ribs with "easy change" system
 .Streben mit "easy change" System
 .Baleines avec "easy change" système
 .Varillas con sistema de " cambio fácil"
 .Baleinen met het "easy change" systeem



.Volume (m3)
 .Volume (m3)
 .Volumen (m3)
 .Volume (m3)
 .Volumen (m3)
 .Volume (m3)



.Camino antivento
 .Wind cap
 .Windfang
 .Souffle
 .Chimenea antiviento
 .Windvang



.Sistema retrattile
 .Retractile system
 .Einziehbares System
 .Système retractile
 .Sistema retráctil
 .Inklapbaar systeem



.Ø Palo (mm)
 .Ø Pole (mm)
 .Ø Mast (mm)
 .Ø Mat (mm)
 .Diametro mm (asta)
 .Ø Mast (mm)



.Volant
 .Valance
 .Volant
 .Volant
 .Volant
 .Faldón
 .Volant



.Base girevole a 360°C
 .Revolving base 360°C
 .360°C drehbarer Staender
 .Base tournant 360°C
 .Base giratoria 360°
 .360° draaibaar



.Massima Stabilità Ottenibile
 .Maximum Obtainable Stability
 .Maximal Erhaeltliche Stabilitaet
 .Maximum De Stabilité Realisable
 .Maxima Estabilidad Posible
 .Maximaal Bereikbare Stabilitéit



.Sezione sostegno (mm)
 .Support section (mm)
 .Mastprofil (mm)
 .Section support (mm)
 .Sección soporte (mm)
 .Mast (mm)



.Blocco antivento
 .Wind stop
 .Windstop
 .Block antivent
 .Freno para el viento
 .Windstop



.Inclinazione fino a 20°
 .Inclination up to 20°
 .Neigung bis zu 20°
 .Inclination jusqu'à 20°
 .Inclinaciòn hasta 20°



.Peso consigliato in condizioni normali
 .Recommended weight in normal condition
 .Empfohlenes gewicht unter normalen bedingungen
 .Poids recommande dans des conditions normales
 .Peso recomendado en condiciones normales
 .Aanbevolen gewicht onder normale omstandigheden



.Ottonatura
 .Brassfinishing
 .Vermessigungen
 .Laiton doré
 .Terminaciones doradas
 .Koper beslag



.Con meccanismo manovella
 .With winding mechanism
 .Mit Kurbelmechanismus
 .Avec mécanisme manivelle
 .Con manivela
 .Met opwindmechanisme



.Inclinazione fino a 60°
 .Inclination up to 60°
 .Neigung bis zu 60°
 .Inclination jusqu'à 60°
 .Inclinaciòn hasta 60°



.Peso minimo richiesto
 .Minimum ballast required
 .Erforderliches mindestgewicht
 .Poids minimum requis
 .Peso minimo requerido
 .Minimaal vereist gewicht

- I Scolaro è un'azienda nata più di 40 anni fa come antico laboratorio artigianale di ombrelloni DOC. L'ampia gamma di articoli è studiata per il Contract, l'arredo giardino e il settore pubblicitario ed è costituita da ombrelloni in legno e alluminio con palo centrale, palo laterale e con telaio telescopico. La politica aziendale costantemente rivolta alla soddisfazione del cliente finale consente ora alla Scolaro di esportare i propri prodotti in più di 50 Paesi. Alla esperienza e capacità manipolativa aggiunge negli anni sempre maggiori tecnologie per migliorare lo standard qualitativo e da semplice prodotto per riparare dal sole ne ha fatto un elegante strumento per l'arredamento personalizzato. Il design, le nuove soluzioni tecniche e l'abbinamento dei materiali migliori, segnano l'evoluzione e l'utilizzo dell'ombrellone, il tutto garantito da un processo produttivo interamente italiano.
- UK The company Scolaro was established 40 years ago and produced artisan wooden parasols. Our wide range of articles is studied for the Contract, the garden furniture and the promotional branch. It includes wooden and aluminium parasols with central pole, side post and telescopic frame. Our company's policy is constantly seeking to customer satisfaction and allows now to export our products in more than 50 countries. The experience and manipulative skill added over the years more and more technologies to improve the quality standard and a simple product developed to shelter from the sun has become an elegant tool to personalize smartly furnishing. The design, new technical solutions and the combination of the best materials, mark the evolution and use of the parasol, guaranteed by an entirely Italian production process.
- D Die Firma Scolaro wurde vor ueber 40 Jahren gegrueudet und stellte urspruenglich handwerksmaessig Qualitaetssonenschirme her. Unsere umfangreiche Auswahl an Artikel eignet sich fuer Gastro-OH, Gartenmoebel Fachhandel und den Werbebereich und schliesst Mittelmast-, Pendel- sowie Teleskopschirme in sich. Die Kundenzufriedenheit ist einer unserer prinzipiellen Objektiv und hat uns erlaubt nun in ueber 50 Laender zu exportieren. Unsere Erfahrung und Handfertigkeit haben alle Erwartungen nach einer besseren Technologie und nach einem hohen Qualitaetsstandard erfuellt. Ein einfaches Produkt zum Schutz vor der Sonne, verleiht heute der Einrichtung eine persoehnliche und elegante Note. Das Design, die technischen Verbesserungen, die Kombination hochwertigster Materialien und das italienische Produktionsprozess kennzeichnen die Entwicklung und den Einsatz des Schirmes.
- F La maison Scolaro a commencé son activité il y a 40 ans avec la production artisanale de parasols en bois. Notre large gamme de parasols est adaptée à l'hôtellerie, le jardin et le marché publicitaire. Elle comprend des parasols avec mâts centraux, mâts déportés et télescopiques. La politique de l'entreprise est constamment à la recherche de la satisfaction des clients. La Société SCOLARO exporte ses parasols dans plus de 50 pays. L'expérience et les compétences de fabrication acquises au fil des ans et les nouvelles technologies ont permis d'améliorer la qualité et un produit simple de la protection du soleil est devenu un objet élégant de mobilier de jardin. Le design, les solutions techniques et la combinaison des meilleurs matériaux soulignent l'évolution et l'utilisation du parasol, garantie par un processus de production entièrement italien.
- E La empresa SCOLARO, fue fundada hace más de 40 años como laboratorio artesano de parasoles. La amplia gama de productos está estudiada para contract, jardín y el sector publicitario, fabricando parasoles tanto en madera, como en aluminio con mastil central o lateral y con estructura telescópica. La política de la empresa está constantemente dirigida a la satisfacción del cliente final, lo que con el tiempo ha permitido que scolaro exporte su producto a más de 50 países. A la experiencia y capacidad manipuladora, hemos incorporado con los años mayores tecnologías para mejorar la normativa de calidad y hacer de un simple producto para protegerse del sol un instrumento elegante para el interiorismo personalizado. El diseño, las nuevas soluciones técnicas y la combinación de los mejores materiales, marca la evolución y utilización de los parasoles, garantizando que todo el producto es de fabricación íntegramente italiana.
- NL Parasolfabrikant SCOLARO startte meer dan 40 jaar geleden met de handmatige fabricage van parasols van hoge kwaliteit. In het uitgebreide assortiment zijn parasols voor zowel gastronomie, tuinmeubelvakhandel als ook voor reclamedoeleinden opgenomen. Parasols zijn, zowel in hout als aluminium, leverbaar als zwendend, met centrale mast en in telescoop uitvoering. Klanttevredenheid is onze bedrijfspolicy. Wij exporteren onze parasols naar meer dan 50 landen. Door onze jarenlange ervaring, opgebouwde kennis en verbeterde technologie zijn wij in staat een hoogwaardig product te fabriceren. Een eenvoudig artikel ter bescherming tegen de zon vraagt tegenwoordig een persoonlijke en elegante uitstraling. Design, nieuwe technische oplossingen in combinatie met hoogwaardige materialen zijn kenmerkend voor de ontwikkeling en het gebruik van Scolaro parasols, waarvan de productie volledig in Italiaanse handen is.

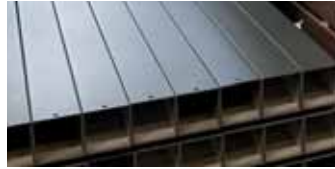
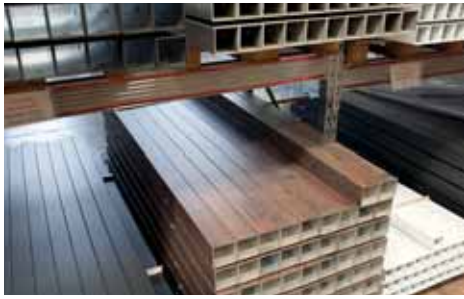



I I nostri articoli sono progettati, sviluppati e prodotti interamente all'interno della nostra azienda con sede in Italia. Particolare cura per la rifinitura e il controllo di qualità sono parte integrante della nostra politica. Grazie ai materiali impiegati e ai dispositivi tecnici i nostri articoli sono particolarmente robusti e adatti per un uso intenso e professionale. L'utilizzo di tessuti acrilici impermeabili, di legno, acciaio e alluminio trattati ne garantiscono una lunga vita. La ditta Scolaro presta particolare attenzione alla facilità di manutenzione e alla disponibilità di componenti di ricambio garantita nel tempo. Al raggiungimento di tali risultati ha sempre collaborato l'Ombrellificio D'Inca che tuttora si occupa della confezione delle coperture.

UK Our products are designed, developed and manufactured entirely inside our company based in Italy. Special care for finishing and quality control are an integral part of our policy. Thanks to the materials used and the technical equipment, our items are strong and suitable for heavy and professional employ. The use of waterproof acrylic fabrics, treated wood, steel and aluminium grant a long life. Particular attention for an easy maintenance and the availability of spare parts is guaranteed over time. To the achievement of these results has always cooperated the company Ombrellificio D'Inca, that still takes care of the parasol cover manufacture.

D Unsere Produkte werden in unserem Unternehmen mit Sitz in Italien geplant, entwickelt und produziert. Besondere Sorgfalt fuer Feinbearbeitung und Qualitätskontrolle sind Bestandteil unserer Politik. Dank der verwendeten Materialien und der technischen Ausstattung sind unsere Produkte sehr stark und fuer einen gewerblichen Einsatz geeignet. Die Verwendung wasserfester Acrylstoffe, behandelte Materialien wie Holz, Stahl und Aluminium gewährleisten eine lange Lebensdauer. Grossen Wert legen wir auf eine Vereinfachung der Wartung und Erhältlichkeit von Ersatzteilen selbst nach vielen Jahren. Diese Ergebnisse konnten auch dank der Zusammenarbeit mit der Firma Ombrellificio D'Inca, die fuer die Produktion der Schirmbezüge zuständig ist, erzielt werden.

F Nos produits sont conçus, développés et fabriqués entièrement au sein de notre société basée en Italie. Une attention particulière pour la finition et le contrôle de la qualité font partie intégrante de notre politique. Grâce aux matériaux utilisés et l'équipement technique, nos produits sont résistants et adaptés à un usage intensif et professionnel. L'utilisation de tissus en acrylique imperméables, ainsi que les matériaux bois, acier et aluminium traité, garantissent une longue durée de vie à nos parasols. L'entreprise SCOLARO accorde une attention toute particulière à la facilité d'entretien des parasols et à la disponibilité de pièces de rechange garanties dans le temps. La société Ombrellificio D'Inca a toujours collaboré à la réalisation des toiles qui contribuent au succès de la qualité de nos parasols.

E Nuestros artículos están diseñados, desarrollados y producidos íntegramente en nuestra fábrica de Italia. Nuestra particular atención al acabado y a los controles de calidad forman parte de nuestra política de empresa. Gracias a los materiales empleados y a los dispositivos técnicos, nuestros productos son particularmente robustos y se adaptan a un uso intenso y profesional. La utilización de tejidos acrílicos impermeabilizados, maderas tratadas, acero y aluminio garantizan una larga durabilidad del producto. La firma Scolaro presta particularmente atención al fácil mantenimiento y a la disponibilidad de repuestos durante mucho tiempo. El logro de estos resultados también se debe a la colaboración de la empresa Parasoles D'Inca, la cual se ocupa de la confección de la cobertura textil.

NL Onze producten worden in onze eigen fabriek in Italië geproduceerd. Extra zorg aan de afwerking en de kwaliteitscontrole zijn een vast onderdeel van ons fabricageproces. Dankzij de gebruikte materialen en de technische uitrusting zijn onze producten zeer sterk en geschikt voor professioneel gebruik. Het gebruik van waterbestendig acryl en behandelde materialen als hout, metaal en aluminium staan borg voor een lange levensduur. Bijzondere zorg besteden wij aan een vereenvoudiging van onderhoud en beschikbaarheid van vervangende onderdelen, ook na vele jaren. Deze resultaten worden mede gerealiseerd door de jarenlange samenwerking met de firma Ombrellificio D'Inca, doekenleverancier voor onze parasols.





Sail - parasol

Vela New



- I L'ombrellone Vela ridefinisce il concetto e l'architettura dell'ombra, inedito e fuori dagli schemi. Il design della copertura si evolve lasciandosi ispirare dal mare e sagomare dal vento, ottenendo linee sinuose ed ergonomiche. Dalla fusione armonica tra un ombrellone e una vela nasce una sinergia tra resistenza dei materiali e leggerezza delle forme. Un oggetto unico per valorizzare il Vostro ambiente esterno.
- UK The parasol Vela redefines the concept and architecture of the shadow, unusual and unconventional. The cover design evolves taking inspiration from the sea and shaped by the wind, resulting in sinuous and ergonomic lines. From the harmonic fusion between a parasol and a sailing a synergy between material strength and lightness of form, takes shape. A unique item to enhance your outdoor environment.
- D Der Sonnenschirm Vela definiert den Begriff und die Architektur des Schattens, ungewöhnlich und unkonventionell. Das Design der Bespannung lässt sich vom Meer inspirieren und durch den Wind modeln. Ergebnis sind ergonomische und gewundene Linien. Von der harmonischen Vereinigung zwischen einem Sonnenschirm und einem Segel nimmt eine Synergie zwischen Festigkeit der Materialien und Leichtigkeit der Form Gestalt an. Ein einzigartiger Schirm der die Aussenausstattung aufwertet.
- F Le parasol Vela redéfinit le concept et l'architecture de l'ombre, insolite et non conventionnelle. La conception de la couverture évolue en s'inspirant de la mer et façonné par le vent, ce qui entraîne des lignes sinueuses et ergonomique. De la fusion harmonieuse entre un parasol et une voile né une synergie entre la résistance des matériaux et la légèreté de la forme. Un article unique pour améliorer votre environnement extérieur.
- E El Parasol Vela redefine el concepto y la arquitectura de la sombra, nuevo y poco convencional. El diseño del tejido evoluciona inspirándose en el mar y las formas que toma el viento, consiguiendo líneas sinuosas y ergonómicas. De la unión armónica entre un parasol y una vela, nace una sinergia entre la resistencia de los materiales y la ligereza de las formas, un objeto único para mejorar su ambiente al aire libre.
- NL De parasol VELA geeft het begrip schaduw anders weer, ongewoon en onconventioneel. De vormgever van het doek liet zich inspireren door de zee en de wind. Het resultaat is ergonomisch met strakke lijnen. Door de harmonieuze samenvoeging van een parasol en een zeil ontstaat een synergie tussen stabiliteit van materialen en luchtigheid van de vormgeving. Een unieke parasol, die een grote bijdrage levert aan de uitstraling van ieder terras.





Galileo White



I Il modello Galileo Retrattile, già molto apprezzato per gli accorgimenti tecnici e per la praticità di utilizzo, è ora disponibile anche con il telaio verniciato a polveri in colore bianco. Questa variante rende il Galileo White ancora più elegante e sofisticato.

UK The model Galileo Retractable, much appreciated for the technical and practical use, is now also available with the frame powder coated in white. This variant makes the Galileo White even more elegant and sophisticated.

D Das Modell Galileo Retractable, bisher insbesondere fuer den technischen und praktischen Einsatz geschätzt, ist nun auch mit pulverbeschichtetem Gestell in Farbe weiß erhältlich. Diese Variante macht das Galileo White noch eleganter und raffinierter.

F Le modèle rétractable Galileo, très apprécié pour l'utilisation technique et pratique, est désormais disponible aussi avec l'armature vernis en couleur blanche. Cette variante rend le Galileo White encore plus élégant et sophistiqué.

E El modelo galileo retrattile, es muy apreciado por los datos tecnicos y por ser muy practico en su uso, y ahora tambien esta disponible con la estructura recubierta con pintura en polvo en color blanco. Esta variante hace al galileo blanco aun mas elegante y sofisticado.

NL Het model Galileo Retrattile, befaamd vanwege het technische en praktische gebruiksgemak, is nu ook verkrijgbaar in wit geëpoxeerde uitvoering. De uitvoering Galileo White is daardoor nog eleganter en chiquer.



urant



Galileo Dark



- I** Nuovo modello con sistema di apertura retrattile permette la facile chiusura dell'ombrellone anche in presenza di arredo. Si tratta del migliore sistema presente nel mercato perché Scolaro, nel progettare e sviluppare ha tenuto conto di: apertura e inclinazione facilitata, estetica, molta attenzione nel prevedere eventuale assistenza o facile riparazione anche ad opera dell'utente finale. Il sistema di inclinazione progettato indipendente dall'apertura e chiusura rende questo modello la migliore soluzione presente nel mercato.
- UK** New model with opening system close on the support that allows an easy closing of the parasol without moving the furniture. It's the best system on the market that Scolaro has developed considering: functionality of the system, aesthetics, special attention in foreseeing a possible assistance or easy restore by the final customer. The inclination system is planned independently from the opening and closing and makes therefore this model the best solution in the market.
- D** Neues Model mit einziehbarem Öffnungssystem oberhalb von Tischen und Stuehlen. Scolaro hat dieses einzigartige System auf dem Markt entwickelt und besondere Beachtung auf folgende Punkte geschenkt: Funktionalitaet des Systems, Aesthetik, spezielle Aufmerksamkeit fuer eventuelle einfache Ersetze seitens des Endverbrauchers. Einzigartiges Model auf dem Markt, dank der unabhaengigen Neigung vom Öffnungs- und Schließungssystem.
- F** Nouveau modèle avec système rétractile au-dessus des tables et chaises. Il s'agit du meilleur système développé sur le marché par Scolaro en tenant compte: du caractère fonctionnel, de l'esthétique, et d'une attention spéciale pour une éventuelle assistance et réparation de la part de l'utilisateur final. Le système d'inclinaison conçu indépendamment de l'ouverture et de la fermeture rend ce modèle la meilleure solution sur le marché.
- E** El nuevo modelo con sistema de apertura retráctil, permite el cierre fácil de la sombrilla, sin mover el mueble. Este es el mejor sistema del mercado que Scolaro ha desarrollado teniendo en cuenta: Funcionalidad del sistema, Estética, Atención especial al prever una posible asistencia o fácil reparación por el cliente final. El sistema de inclinación diseñado independientemente del de apertura y cierre, hace que éste modelo sea la mejor solución presente en el mercado.
- NL** Nieuw systeem voor het openen en sluiten van de zwevende parasol, zonder uw tuinmeubilair daarvoor te moeten verplaatsen. De parasol hoeft nu niet meer verwijderd te worden als u deze niet gebruikt, maar wordt bevestigd aan de mast. Dus geen storende parasol en parasolarm meer boven uw tuinmeubilair als de parasol niet als zodanig gebruikt wordt. Dit unieke systeem is door Scolaro ontwikkeld, waarbij extra aandacht besteed is aan belangrijke punten zoals: Functionaliteit, Vormgeving, Aan het mogelijk vervangen van onderdelen door de consument is extra aandacht besteed. Enige in zijn soort op de parasolmarkt dankzij het onafhankelijke open- en sluitsysteem.

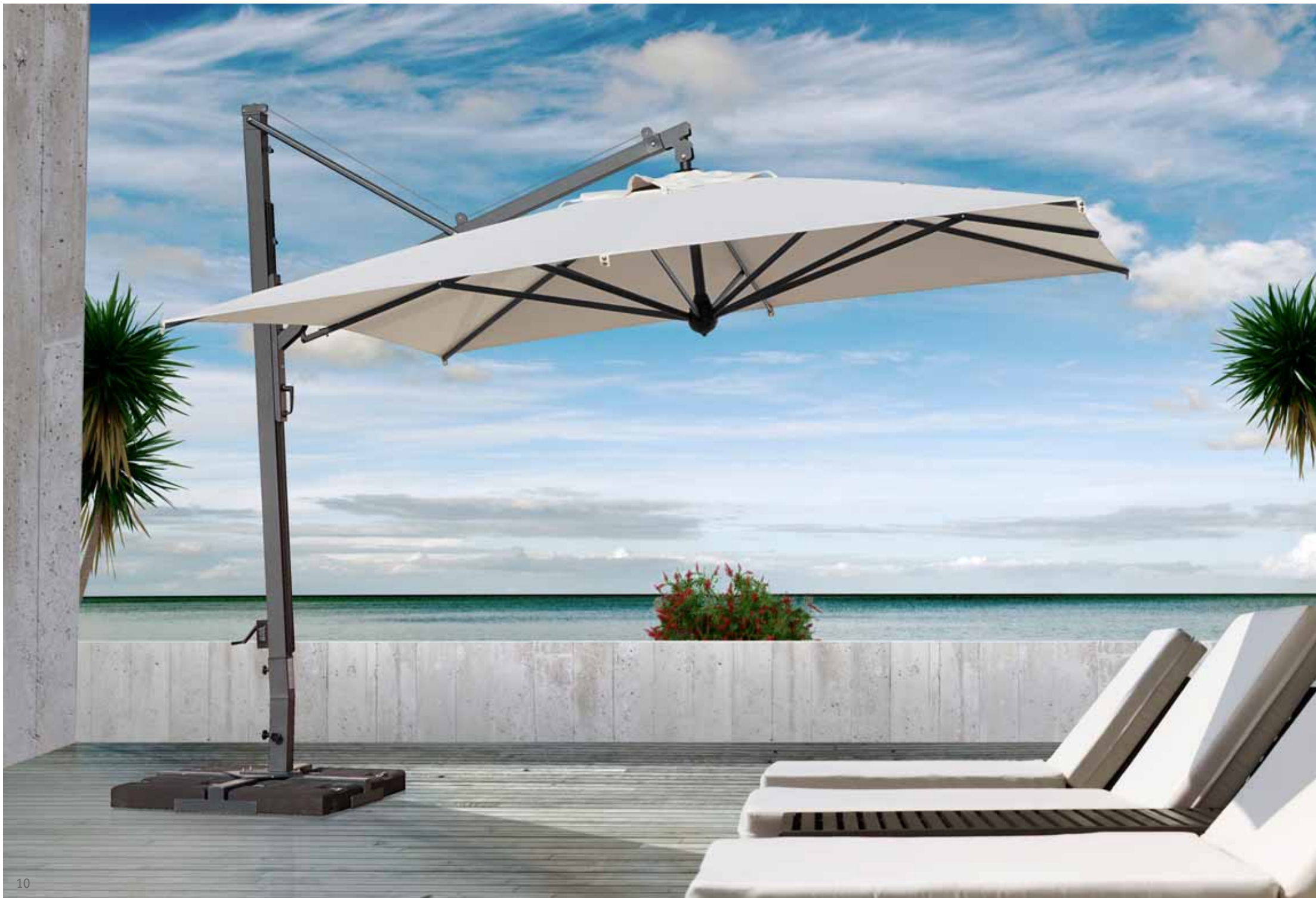



Galileo Maxi 4x4 **New**



I L'ombrellone a braccio laterale con il sistema di chiusura retrattile è ora disponibile anche nella misura 4x4 mt con la struttura ulteriormente irrobustita.

UK The cantilever parasol with retractable closing system is now also available in size 4x4 mt with a further strengthened structure.

D Der Seitenarmschirm mit einziehbarem Schliessungssystem ist nun auch in Groesse 4x4 m erhaeltlich, mit verstaerkter Struktur.

F Le parasol à bras latéral avec système de fermeture rétractable est maintenant également disponible en format 4x4 mt avec la structure renforcée.

E Parasol de brazo lateral y con sistema de cierre ó plegado retráctil. Ahora también disponible en el tamaño de 4 x 4 mts, y con la estructura aún más reforzada.

NL De zwevende parasol, die sluit aan de mast, is nu ook leverbaar in de afmeting 4 x 4 mtr. in een verzwaarde uitvoering.



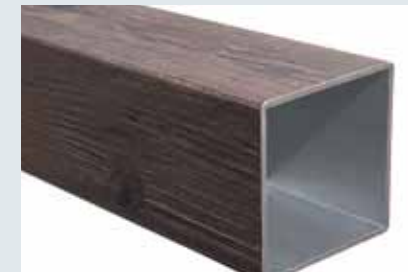
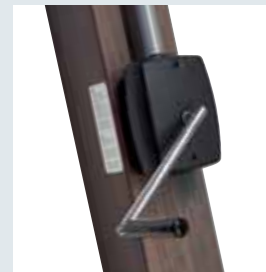

Giotto Braccio



I Il contrasto di elementi come la finitura color legno Tabacco anticato e i componenti in alluminio color acciaio portano ad un livello superiore la ricerca del lusso. In esclusiva e anteprima Scolaro introduce un nuovo sistema di finitura applicata al sostegno in alluminio con uno speciale rivestimento in colore tabacco anticato che riproduce il legno in 3D.

UK The contrast of elements with wooden tobacco coloured finishing and steel coloured aluminium components lead to an higher level the research of luxury. Scolaro introduces a new finishing applied to the aluminium support with a special coating tobacco antique wood that mimics wood in 3D.

D Der Kontrast der Elemente mit Antique Tobacco Effekt und Alubestandteile Edelstahlfarbig pulverbeschichtet verleihen diesem Model eine besonders luxuriöse Note. Scolaro führt als Erster Alumaeste mit speziellem 3D Holzeffekt Antique Tobacco ein.

F Le contraste des éléments tels que la finition couleur bois tabac antique et des composants en aluminium couleur acier, portent la recherche de luxe à un niveau supérieur. Scolaro a créé une nouvelle finition au niveau du mât en aluminium avec un revêtement spécial effet bois tabac antique en 3D.

E El contraste de elementos como el acabado color madera Tabacco envejecido así como los componentes de aluminio color acero conducen a un nivel superior en cuanto a la búsqueda de lujo. Scolaro introduce un nuevo acabado aplicado sobre el soporte de aluminio con un recubrimiento especial en color Tabacco antiguo que reproduce la madera en 3D.

NL Contrast in materialen: de aluminium mast met tabakskleurige hout-look, de overige aluminium delen [baleinen] geëpoxeerd in een roestvrij staal-look geven dit model een bijzonder luxe uitstraling. Scolaro komt als eerste fabrikant op de markt met een aluminium parasolmast in 3D, die vrijwel niet te onderscheiden is van hout.





Aluminium

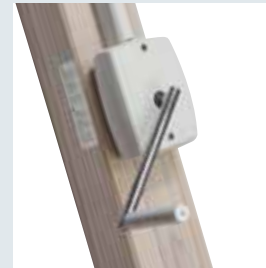

Milano Braccio **New**



I Un armoniosa combinazione di materiali come il frassino sbiancato e i componenti verniciati colore bianco lucido rendono il nuovo Milano Braccio unico per eleganza e riservato agli ambienti più esclusivi.

Nuovo sostegno verticale previsto in alluminio con speciale finitura effetto frassino sbiancato per un design inalterato nel tempo.

UK Harmonious combination of materials like ash wood and white epoxy, polish lacquered components that make this new item Milano Braccio elegant and suitable for the most exclusive milieu.

New vertical aluminium support provided with special bleached ash wood finishing for an unalterable Design.

D Harmonische Kombination von Materialien wie Eschenholz und Bestandteile in Farbe weiss pulverbeschichtet. Neues elegantes Model besonders fuer die exklusivsten Milieux geeignet.

Neuer Alumast mit speziellem ausgebleichtem Eschenholz Effekt. Unveraenderliches Design.

F Harmonieuse combinaison des matériaux comme le frêne et composants vernis blanc que nous utilisons pour ce nouveau parasol Milano Braccio, un modèle élégant et adapté pour les milieu les plus raffinés.

Nouvelle mat vertical en aluminium avec finition effet bois de frêne permettant un design inchangé.

E Armoniosa combinación de materiales como el fresno blanqueado, pulido y lacado, que hacen de este nuevo artículo un modelo elegante y apropiado para los ambientes más exclusivos.

El nuevo soporte vertical fabricado en aluminio y con acabado especial en imitación maderada color ceniza blanqueada, hace que éste diseño sea inalterable en el tiempo

NL Harmonieuze combinatie van essenhout en wit geëpoxeerd metaal. Nieuw elegant model. Zeer geschikt voor exclusieve locaties. Aluminium mast met unieke essenhout uitstraling.

Solide zwevende designparasol. Nu met nieuwe aluminium mast met uniek essenhouten uitstraling, baleinen in wit essenhout. Aluminium en metalen delen zijn wit geëpoxeerd.

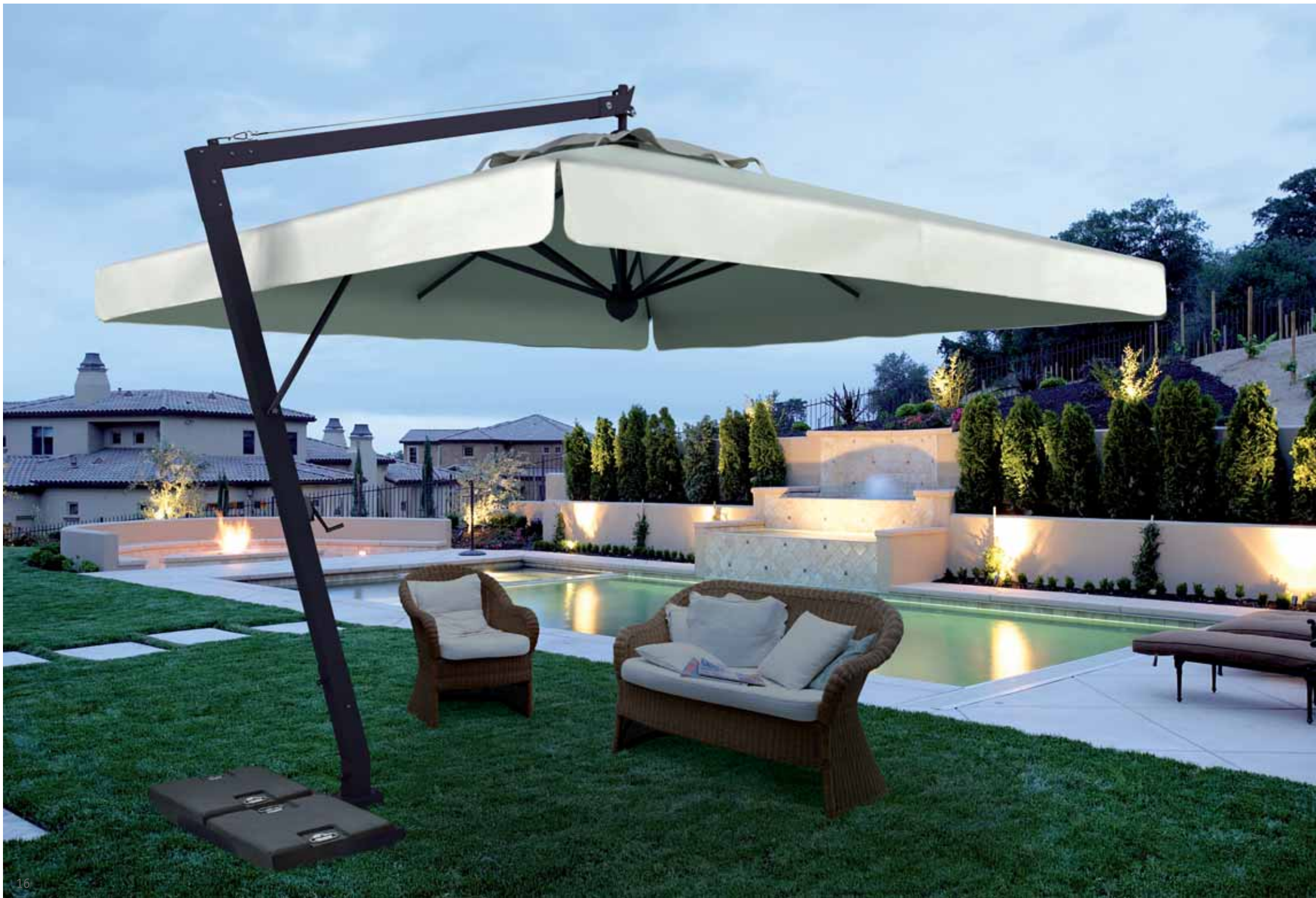



C4040 LEB

Leonardo Braccio



- | | | | | | |
|---|--|---|--|---|--|
| <p>I Rinnovato modello completamente in acciaio e alluminio verniciati a polveri epossidiche grigio antracite. Ombrellone particolarmente robusto e adatto per uso professionale.</p> | <p>UK Renewed model completely in steel and aluminium epoxy lacquered. Particularly strong parasol suitable for a professional employ.</p> | <p>D Erneueres Model ganz aus pulverbeschichtetem Stahl und Aluminium. Besonders starker Schirm geeignet fuer einen gewerblichen Einsatz.</p> | <p>F Modèle complètement retravaillé en acier et aluminium avec vernis époxy. Parasol particulièrement robuste et adapté pour une utilisation professionnelle.</p> | <p>E Modelo completamente renovado en acero y aluminio lacado. Sombrilla particularmente fuerte, apropiada para usos profesionales.</p> | <p>NL Vernieuwd model, geheel gefabriceerd uit geëpoxeerd staal en aluminium. Een ideale parasol voor intensief gebruik (waaronder de horeca).</p> |
|---|--|---|--|---|--|





Aluminium

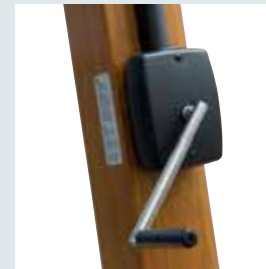

Palladio Braccio **New**



I Modello di ombrellone prodotto da Scolaro da oltre 20 anni opportunamente aggiornato nel tempo. Dimostra l'ottima progettazione iniziale e riassume la tradizione ed esperienza nel settore, confermato anche dalle migliaia di unità vendute in tutto il mondo. **Nuovo Sostegno verticale previsto in alluminio con speciale finitura effetto legno ancora più robusto e duraturo.**

UK Model produced by Scolaro since over 20 years opportunely renewed. Thousand of pieces sold worldwide, of which many are still employed, are the proof of an optimal planning and that this item sums up tradition and experience in the branch. **New Vertical aluminium support provided with special wood finishing for an unalterable Design.**

D Scolaro stellt dieses Model seit ueber 20 Jahren her und hat es mit der Zeit stets erneuert und verbessert. Die tausenden Teile, die weltweit verkauft wurden und stets noch eingesetzt werden sind der Beweis einer optimalen Planung und der erfolgreichen Kombination von Tradition und Erfahrung in der Branche. **Neuer Alumast mit speziellem Holz Effekt. Unveraenderliches Design.**

F Modèle de parasol fabriqué par Scolaro depuis plus de 20 ans et relooké. Les milliers de pièces vendus dans le monde sont la preuve de la qualité, robustesse et succès que connaît le modèle Palladio et du professionnalisme de la ste Scolaro. **Nouvelle Mat vertical en aluminium avec finition effet bois permettant un design inchangé.**

E Modelo fabricado por Scolaro desde hace 20 años, oportunamente renovado. Se vendieron miles de piezas (sombrillas) por todo el mundo, de las cuales muchas aún son utilizadas, y esto es la prueba de que este artículo resume la tradición y la experiencia en el sector. **El nuevo soporte vertical fabricado en aluminio con acabados especiales imitación madera, lo hacen más robusto y duradero.**

NL Dit model wordt door Scolaro al meer dan 20 jaar op de markt gebracht en is gedurende die tijd steeds aan de actualiteit aangepast. De vele duizenden die er in de afgelopen jaren wereldwijd verkocht zijn, leveren het bewijs voor uitstekende kwaliteit; dit dankzij de succesvolle combinatie van vakmanschap en ervaring. Aluminium mast met unieke essenhout uitstraling. **Solide zwevende designparasol. Nu met nieuwe aluminium mast met uniek essenhouten uitstraling, baleinen in wit essenhout. Aluminium en metalen delen zijn wit geëpoxeerd.**



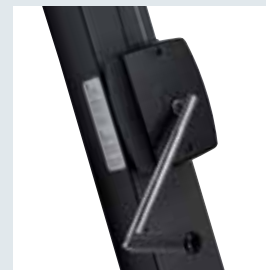

Aluminium

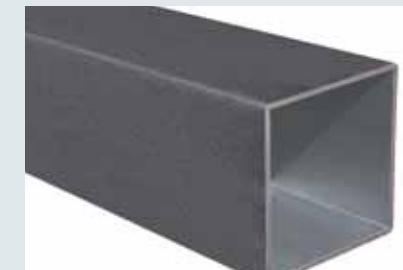

Napoli Braccio



I La praticità della soluzione a braccio laterale interamente in acciaio e alluminio verniciato antracite mantiene il design raffinato inalterato nel tempo.

UK Handy cantilever parasol entirely made of epoxy lacquered steel and aluminium, keeps its refined design unchanged.

D Praktischer Pendelschirm ganz aus pulverbeschichtetem Stahl und Aluminium. Unveraenderliches und raffiniertes Design.

F Parasol pratique avec bras excentré en acier et aluminium vernis qui n'altère en rien le design.

E Práctica sombrilla completamente fabricada en acero y aluminio lacados, reservado para diseños inalterados y refinados.

NL Praktische zwevende parasol geheel in geepoxideerd staal en aluminium. Uniek door zijn geraffineerde vormgeving.





Rimini Braccio



I Questo modello, rinnovato completamente in acciaio e alluminio verniciati a polveri epossidiche colore bianco, si inserisce perfettamente in ambienti moderni e ricercati.

UK Renewed model completely in steel and aluminium epoxy lacquered colour white. Perfectly fitting with modern and precious milieux.

D Erneuerter Model ganz aus pulverbeschichtetem Stahl und Aluminium Farbe weiss. Speziell fuer moderne und besondere Milieux geeignet.

F Modèle complètement relooké en acier et aluminium avec vernis époxy couleur blanc. Parasol particulièrement adapté aux milieux contemporains et raffinés.

E Modelo completamente renovado en acero y aluminio lacado en blanco. Se inserta perfectamente tanto en ambientes modernos como cargados (clásicos, rebuscados).

NL Vernieuwd model, geheel gefabriceerd uit geëpoxeerd staal en aluminium in de kleur wit. Bij uitstek geschikt voor mensen die een luxe en exclusieve parasol zoeken.



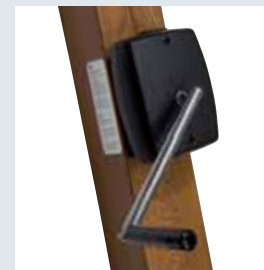

Aluminium



Torino Braccio



I Un grande classico caratterizzato dall'impiego del legno. Nuovo sostegno in alluminio con finitura legno che ne migliora le prestazioni senza alterarne l'estetica.

UK A great classic characterized by the employ of wood. New aluminium support with wood finishing that improves the performance without altering the aesthetics.

D Ein grosser Klassiker aus Holz. Der neue Alumast mit Holzeffekt verbessert die Leistung ohne die Aesthetik des Schirmes zu veraendern.

F Un grand classique caractérisé par l'utilisation du bois. Nouveau mât en aluminium avec une belle finition bois qui améliore les qualités du parasol sans en altérer l'esthétique et le design

E Un gran clásico caracterizado por el uso de la madera. Nuevo soporte de aluminio con acabado de madera que mejora el rendimiento sin alterar la estética.

NL Een houten klassieker. De nieuwe aluminium mast met hout-look verbetert de kwaliteit zonder dat die de uitstraling van de parasol verandert.





Milano Standard



I Il nome comunica tutto il significato di un prodotto realizzato in Italia: sapiente esempio di qualità e design con il risultato di un'eleganza unica.

UK The name transmits the meaning of this item realized in Italy: Wise example of quality, design and elegance.

D Der Name uebertraegt die Eigenschaften dieses Modells italienischer Herstellung: Vorbild von Qualitaet, Design und Eleganz.

F Le nom traduit le sens du produit réalisé en Italie: Modèle de qualité, design et élégance.

E Su nombre transmite lo que quiere decir este artículo fabricado en Italia: Claro ejemplo de calidad, diseño y elegancia.

NL De naam is synoniem aan de eigenschappen van deze Italiaanse parasol. Toonbeeld van kwaliteit, design en elegantie.





Napoli Standard



I Combinazione del telaio in alluminio antracite con la semplicità delle linee per un connubio perfetto tra resistenza ed eleganza.

UK Combination of an aluminium frame colour anthracite grey and the simplicity of its lines. Perfect union between resistance and elegance.

D Alugestell in Farbe Anthrazitgrau und schlichte Linien sind die perfekte Verbindung zwischen Widerstandsfähigkeit und Eleganz.

F Armature en aluminium couleur gris anthracite avec des lignes pures. Harmonieuse combinaison de résistance et d'élégance.

E Combinación con marco de aluminio en color antracita y líneas sencillas. Perfecta unión entre resistencia y elegancia.

NL Combinatie van antraciet grijs aluminium frame en eenvoud in belijning. Een perfecte balans tussen degelijkheid en styling.





Palladio Standard

I Modello storico, presente nella gamma Scolaro da più di 30 anni. La linea classica, ma allo stesso tempo semplice ed essenziale lo rendono adatto a tutti gli ambienti e inattaccabile da tendenze di moda. Prodotto più venduto e diffuso. Ampia gamma e varianti disponibili.

UK Historical model belonging to the Scolaro range since over 30 years. Classic line, but at the same time simply and essential, always in fashion and therefore suitable for all milieux. The most sold item. Wide range of sizes and variants.

D Historisches Model, in der Scolaro Kollektion seit ueber 30 Jahren. Klassisch, einfach, fuer alle Milieux geeignet und stets modern. Meistverkaufter Artikel. Umfangreiche Auswahl an Masse und Varianten.

F Modèle historique, parasol de la collection Scolaro depuis plus de 30 ans. Ligne classique et élégante. Adapté pour tous les milieux. Le modèle le plus vendu. Large gamme avec variantes disponibles.

E Modelo histórico perteneciente a Scolaro desde hace 30 años. Línea clásica, pero al mismo tiempo simple y esencial, siempre moderna y por lo tanto adecuado para todos los ambientes. Es el artículo más vendido. Con amplia gama de tamaños y variantes.

NL Al meer dan 30 jaar de topper in het SCOLARO assortiment. Klassiek, strak en toch steeds modern. Geschikt voor vele locaties. Het meest verkochte model. Een breed assortiment in vele maten en kleuren.







Leonardo Telescopic



I Il sistema telescopico che permette l'apertura e la chiusura al di sopra di tavoli e sedie abbinato al telaio in alluminio rendono l'ombrellone Leonardo Telescopic resistente, leggero e di facile utilizzo.

UK The telescopic opening system over tables and chairs combined with the employ of an aluminium frame grant strength, lightness and easy employ.

D Das teleskopische Oeffnungssystem oberhalb von Tischen und Stuehlen und das Aluminiumgestell machen aus diesem Schirm eine leichte jedoch starke und fuer einen gewerblichen Einsatz geeignete Version.

F L'ouverture telescopique au-dessus de tables et chaises font de ce article un parasol résistant, léger et apte pour un emploi professionnel.

E El sistema telescópico permite abrir y cerrar el parasol por encima de las mesas siendo de este modo un parasol resistente, ligero y de fácil uso.

NL Dankzij het telescoopsysteem is het ook mogelijk bij grotere afmetingen parasols deze te sluiten boven de tafel. Zeer geschikt voor professioneel gebruik.





Palladio Telescopic

I La versione telescopica, progettata e sviluppata per prima da Scolaro, propone una apertura e chiusura dell'ombrellone facile e funzionale al di sopra di tavoli e sedie.

UK The telescopic version Palladio, planned and developed first by Scolaro, offers an easy and functional opening and closing over tables and chairs

D Die Teleskopversion Palladio, die Scolaro als Erster entwickelt und angeboten hat, bietet eine einfache und funktionelle Öffnung und Schliessung oberhalb von Tischen und Stuehlen an.

F La ligne Palladio télescopique, que Scolaro a projeté et développé par premier, offre une ouverture et fermeture facile et fonctionnel.

E La versión telescópica, planeada y desarrollada por la primera vez de Scolaro, propone una apertura y un cierre de la sombrilla fácil y funcional por encima de mesas y sillas.

NL De telescoopversie, die Scolaro als eerste ontwikkeld heeft, biedt een eenvoudige oplossing om ook grote parasols (Ø 5,00 mtr.) boven de tafel te laten sluiten.





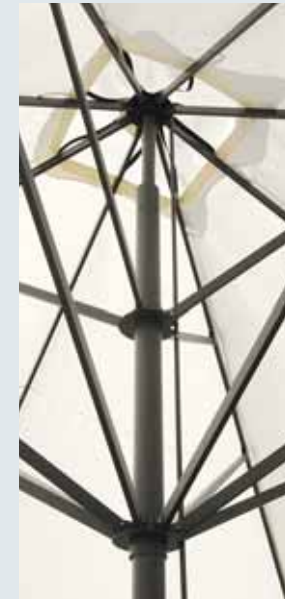

Capri



I La linea Capri presenta l'ombrellone in alluminio progettato per coprire grandi superfici con il minimo ingombro. La robustezza dei materiali e dei componenti e il sistema di apertura telescopico lo rende di facile utilizzo e ideale per un uso professionale.

UK The aluminium range Capri is projected to cover big surfaces taking the minimum space. The strength of the materials and components and the telescopic opening system allow an easy and professional employ.

D Die Version Capri aus Aluminium ist fuer grosse Flaechen geeignet. Die Staerke der Materialien und der Bestandteile und das teleskopische Oeffnungssystem eignen sich insbesondere fuer einen gewerblichen Einsatz.

F La ligne Capri en aluminium est étudiée pour couvrir de grandes surfaces avec un encombrement minimum. La robustesse des matériaux et des composants, l'ouverture telescopique rendent ce parasol apte pour un emploi facile et professionnel.

E La línea CAPRI en aluminio esta concebido para cubrir grandes superficies ocupando el mínimo espacio. La resistencia de los materiales y de sus componentes, además de un moderno sistema de abertura telescópica, permite a este parasol, tener una utilización sencilla y profesional.

NL CAPRI: een parasol met een aluminium frame en bij uitstek geschikt voor het overkappen van grotere terrassen. De teleskoop uitvoering maakt deze parasol ook zeer geschikt voor professioneel gebruik.





Aluminium

Milano Poker/Double **New**



- I Struttura modulare composta da 2 (Double) o 4 (Poker) ombrelloni ancorati ad un unico sostegno studiata per la copertura di ampie superfici con il minimo ingombro.
Ora disponibile anche con sostegno in alluminio con finitura frassino sbiancato e stecche in legno frassino.
- UK Structure made of 2 (Double) or 4 (Poker) parasols fixed at the same pole, suitable for big surfaces and minimum encumbrance.
Now also available with aluminium support provided with special bleached ash wood finishing and bleached ash wood ribs.
- D Struktur mit 2 (Double) oder 4 (Poker) Schirmen, die am selben Mast befestigt sind. Raumsparend und fuer grosse Flaechen geeignet.
Nun auch mit Alu Mast mit speziellem Eschenholzeffekt und Streben aus ausgebleichtem Eschenholz erhaltlich.
- F Structure avec 2 (Double) ou 4 (Poker) parasols fixés à un mat. Pour grandes surfaces avec encombrement minimum.
Maintenant aussi disponible avec support en aluminium finition bois frêne et baleines de bois de frêne.
- E Estructura modular compuesta por 2(doble) o 4 (poker) parasoles unidos por un solo mástil, muy adecuado para amplias superficies con poco espacio.
Nuevo soporte en aluminio con acabados color ceniza blanqueada, y componentes en aluminio y acero pintados en polvo color blanco.
- NL Parasolmast met 2 (Double) of 4 (Poker) parasols. Deze parasols (Double ca. 25 m² en Poker ca. 50 m²) zijn aan 1 mast bevestigd. Zijn daardoor ruimtebesparend en ze er geschikt voor grotere oppervlakten en terrassen.
Aluminium mast met unieke essenhout uitstraling. Solide zwevende designparasol.





Aluminium



Alu Poker/Double

I Struttura modulare in alluminio composta da 2 (Double) o 4 (Poker) ombrelloni ancorati ad un unico sostegno studiata per la copertura di ampie superfici con il minimo ingombro.

UK Aluminium structure made of 2 (Double) or 4 (Poker) parasols fixed at the same pole, suitable for big surfaces and minimum encumbrance.

D Alustruktur mit 2 (Double) oder 4 (Poker) Schirmen, die am selben Mast befestigt sind. Raumsparend und fuer grosse Flaechen geeignet.

F Structure en aluminium avec 2 (Double) ou 4 (Poker) parasols fixés à un mat. Pour grandes surfaces avec encombrement minimum.

E Estructura modular de aluminio compuesta por 2(doble) o 4 (poker) parasoles unidos por un solo mástil, muy adecuado para amplias superficies con poco espacio.

NL Parasolmast met 2 (Double) of 4 (Poker) parasols. Deze parasols (Double ca. 25 m² en Poker ca. 50 m²) zijn aan 1 mast bevestigd. Zijn daardoor ruimtebesparend en ze er geschikt voor grotere oppervlakten en terrassen.







Wood Poker/Double



I Struttura modulare in legno composta da 2 (Double) o 4 (Poker) ombrelloni ancorati ad un unico sostegno studiata per la copertura di ampie superfici con il minimo ingombro.

UK Wooden structure made of 2 (Double) or 4 (Poker) parasols fixed at the same pole, suitable for big surfaces and minimum encumbrance.

D Holzstruktur mit 2 (Double) oder 4 (Poker) Schirmen, die am selben Mast befestigt sind. Raumsparend und fuer grosse Flaechen geeignet.

F Structure en bois avec 2 (Double) ou 4 (Poker) parasols fixés à un mat. Pour grandes surfaces avec encombrement minimum.

E Estructura modular de madera compuesta por 2(doble) o 4 (poker) parasoles unidos por un solo mástil, muy adecuado para amplias superficies con poco espacio.

NL Parasolmast met 2 (Double) of 4 (Poker) parasols. Deze parasols (Double ca. 25 m² en Poker ca. 50 m²) zijn aan 1 mast bevestigd. Zijn daardoor ruimtebesparend en ze er geschikt voor grotere oppervlakten en terrassen.

Bases



BT45 - BT55 - BT65

- Tubo in acciaio zincato. Doppio galletto. Viteria inclusa.
- Steel zined tube. Double wing nut. Screws included.
- Verzinkte Stahlhulse. Doppelte Hutmutter. Schrauben inbegriffen.
- Tube acier zingué. Avec écru papillon. Visserie incl.
- Tubo de acero galvanizado. Los tornillos incluidos.
- Koker gegalvaniseerd. Inclusief schroeven.

	COD				KG
-	BT45	42 mm	45 mm	36-40 mm	1
-	BT55	52 mm	55 mm	47-50 mm	1
-	BT65	62 mm	65 mm	55-60 mm	1



BTT55 - BTT65

- Tubo acciaio per fissaggio a terra. Eventualmente da abbinare all'articolo BTC.
- Steel tube for ground fixing. Possibility to combine it with Art BTC.
- Stahlhulse fuer Bodenbefestigung. Eventuell mit Art BTC kombinierbar.
- Tube en acier pour fixation au sol. Eventuellement à joindre avec BTC.
- Tubo de acero para sujeción al suelo. Posiblemente para que coincida con el artículo BTC.
- Metalen koker voor betonanker. Te gebruiken in combinatie met artikel BTC.



BTC

- Supporto da interrare. Da abbinare a BTT55 e BTT65
- support for ground fixing. To combine with BTT55 and BTT65.
- Staender zum einbetonieren. Kombinierbar mit BTT55 und BTT65.
- Pied pour fixation au sol. A joindre avec BTT55 et BTT65.
- Pie para fijar al suelo. Combinar con BTT55 y BTT65.
- Betonanker, te gebruiken in combinatie met BTT55 en BTT65.

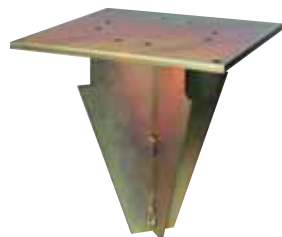
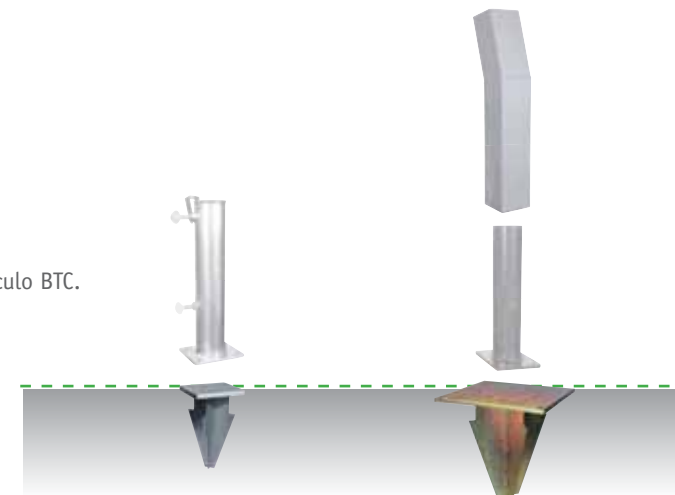

BTB

- Supporto da interrare. Per ombrelloni a braccio, Poker/Double, Capri.
- support for ground fixing. For cantilever parasols, Poker/Double, Capri.
- Staender zum einbetonieren. Fuer Pendelschirme, Poker/Double, Capri.
- Pied pour fixation au sol. Pour parasols avec bras deporté, Poker/Double, Capri.
- Pie para fijar al suelo. Para parasoles de brazo lateral, Poker/Double, Capri.
- Betonanker voor vrijhangende parasols, Poker/Double, Capri.

	COD				KG
-	BTT55	52 mm	55 mm	47-50 mm	1
-	BTT65	62 mm	65 mm	55-60 mm	1
80x120 mm	BTC	-	-	-	1,5
300x300 mm	BTB	-	-	-	10

Bases



BF6565D

- Base in acciaio colore antracite. Spessore 1,5cm. Tubo incl.
- Steel base colour antracite grey. Thickness 1,5cm. Tube incl.
- Stahlstaender grau pulverbeschichtet. Dicke 1,5cm. Huelse inbegriffen.
- Pied en acier vernis coul. gris. Epaisseur 1,5cm. Tube incl.
- Pie de acero de color antracita. 1,5 cm de espesor. Tubo incluido.
- Parasolvoet grijs geëpoxeerde metaalplaat. Dikte 1,5 cm. Wordt geleverd met koker.

650x650 mm	COD				KG
	BF6565D/T45	42 mm	45 mm	36-40 mm	
BF6565D/T55	52 mm	55 mm	47-50 mm		
BF6565D/T65	62 mm	65 mm	55-60 mm		



BF6666D

- Base in acciaio colore antracite. Spessore 2,5cm. Tubo incl.
- Steel base colour antracite grey. Thickness 2,5cm. Tube incl.
- Stahlstaender grau pulverbeschichtet. Dicke 2,5cm. Huelse inbegriffen.
- Pied en acier vernis coul. gris. Epaisseur 2,5cm. Tube incl.
- Pie de acero color antracita. Espesor de 2,5 cm. Tubo incl.
- Parasolvoet grijs geëpoxeerde metaalplaat. Dikte 2,5 cm. Inclusief grijs geëpoxeerde koker

650x650 mm	COD				KG
	BF6666D/T45	42 mm	45 mm	36-40 mm	
BF6666D/T55	52 mm	55 mm	47-50 mm		
BF6666D/T65	62 mm	65 mm	55-60 mm		



BF6565Z

- Base in acciaio zincato. Spessore 1,5cm. Tubo incl.
- Zincd steel base. Thickness 1,5cm. Tube incl.
- Verzinkter Stahlstaender. Dicke 1,5cm. Huelse inbegriffen.
- Pied en acier zinqué. Epaisseur 1,5cm. Tube incl.
- Base de acero. 1,5 cm de espesor. Tubo incluido.
- Parasolvoet gegalvaniseerde metaal. Dikte 1,5 cm. Wordt geleverd met koker.

650x650 mm	COD				KG
	BF6565Z/T45	42 mm	45 mm	36-40 mm	
BF6565Z/T55	52 mm	55 mm	47-50 mm		
BF6565Z/T65	62 mm	65 mm	55-60 mm		

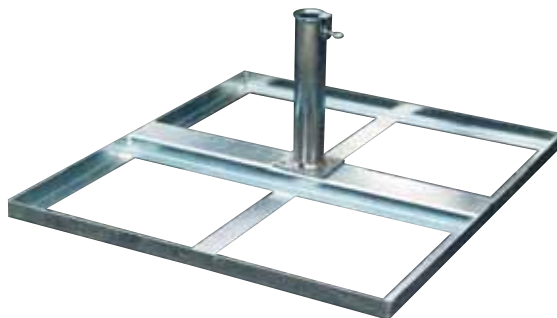

BLZ

- Base in acciaio. Disponibile con BTT55 e BTT65. Tubo incluso
- Zincd steel base. Available with BTT55 and BTT65. Tube incl.
- Stahlplattenstaender. Verfuegbar mit BTT55 und BTT65. Huelse inbegriffen.
- Pied en acier. Disponible avec BTT55 et BTT65. Tube incl.
- Base de acero. Disponible en BTT55 y BTT65. Tubo incluido.
- Parasolvoet gegalvaniseerde metaal voor betontegels (niet inbegrepen)
- Leverbaar met BTT 55 en BTT 65. Wordt geleverd met koker.



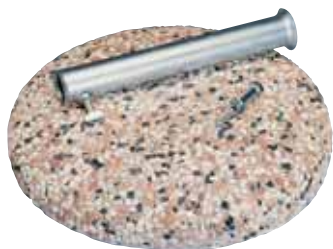

800x950 mm	COD				KG
	BLZ/T55	52 mm	55 mm	47-50 mm	
BLZ/T65	62 mm	65 mm	55-60 mm		

Bases



BC35 – BC55





- Base in cemento graniglia. Disponibile con tubo BT45, BT55, BT65 Tubo incluso.
- Cement grit base. Available with tube BT45, BT55, BT65. Tube incl.
- Kiesbetonstaender. Veruegbar mit Huelse BT45, BT55, BT65. Huelse inbegr.
- Pied ciment grès. Disponible avec tube BT45, BT55, BT65. Tube incl.
- Base de cemento y arena. Disponible con tubo BT45, BT55, BT65. Tubo incluido.
- Parasolvoet gewassen grind. Inclusief koker, maat naar keuze: BT45, BT55, BT65.

		COD				KG
Ø 540 mm		BC35/T45	42 mm	45 mm	36-40 mm	35 kg
		BC35/T55	52 mm	55 mm	47-50 mm	
		BC35/T65	62 mm	65 mm	55-60 mm	
Ø 600 mm		BC55/T45	42 mm	45 mm	36-40 mm	55 kg
		BC55/T55	52 mm	55 mm	47-50 mm	
		BC55/T65	62 mm	65 mm	55-60 mm	



BC55M - BC80M

- Base in cemento graniglia. Disponibile con tubo BT45, BT55, BT65. Tubo incluso
- Cement grit base. Available with tube BT45, BT55, BT65. Tube incl.
- Kiesbetonstaender. Veruegbar mit Huelse BT45, BT55, BT65. Huelse inbegr.
- Pied ciment grès. Disponible avec tube BT45, BT55, BT65. Tube incl.
- Base de cemento. Disponible con tubo BT45, BT55, BT65. Tubo incluido.
- Parasolvoet gewassen grind. Inclusief koker, maat naar keuze: BT45, BT55, BT65.

		COD				KG
Ø 600 mm		BC55M/T45	42 mm	45 mm	36-40 mm	55 kg
		BC55M/T55	52 mm	55 mm	47-50 mm	
		BC55M/T65	62 mm	65 mm	55-60 mm	
Ø 640 mm		BC80M/T45	42 mm	45 mm	36-40 mm	80 kg
		BC80M/T55	52 mm	55 mm	47-50 mm	
		BC80M/T65	62 mm	65 mm	55-60 mm	

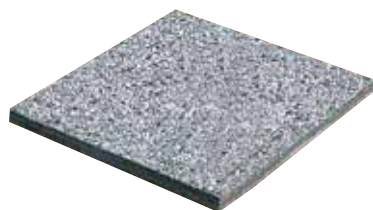

BC 4040 - BC 5050

- Piastra in cemento e graniglia. Spessore 4cm. Per base Art BLZ (4040). Per ombrelloni a braccio (5050).
- Cement grit slab. Thickness 4cm. For base Art BLZ (4040). For cantilever parasols (5050).
- Kiesbetonplatte. Dicke 4cm. Fuer Staender Art BLZ (4040). Fuer Pendelschirme (5050).
- Dalles ciment et grès. Epaisseur 4cm. Pour pied Art BLZ (4040). Pour parasols avec bras deporté (5050).
- Planchas de hormigón y de grava. De espesor 4 cm. Para base BLZ (4040). Para parasoles con voladizo (5050).
- Gewassen grindtegel. Gewicht 20 kg. Dikte 4 cm. Voor Parasolvoet type BLZ (4040). Voor vrijhangende parasols (5050).



		COD	KG
400X400 mm		BC 4040	14 kg
500X500 mm		BC 5050	20 kg

Bases



BC 5151



Piastra in cemento e graniglia con maniglie. Spessore 11cm. Per ombrelloni a braccio.
 Cement grit slab with handles. Thickness 11cm. For cantilever parasols
 Kiesbetonplatte mit Handgriffen. Dicke 11cm. Fuer Pendelschirme.
 Dalles ciment et grès avec poignées. Epaisseur 11cm. Pour parasols avec bras deporté
 Placas de hormigón y arena con asas. De espesor 11 cm Para parasoles con voladizo.
 Gewassen grindtegel met handgrepen. Dikte 11 cm. Geschikt voor vrijhangende parasols.

		
500X500 mm	BC 5151	60 kg



BC 5151G

Piastra in cemento grigio con maniglie. Spessore 11cm. Per ombrelloni a braccio.
 Concrete grey cement slab with handles. Thickness 11cm. For cantilever parasols
 Graue Betonplatte mit Handgriffen. Dicke 11cm. Fuer Pendelschirme.
 Dalles ciment couleur gris avec poignées. Epaisseur 11cm. Pour parasols avec bras deporté
 Base de cemento gris con asas. De espesor 11 cm. Para parasoles con voladizo.
 Betontegel grijs met handgrepen. Dikte 11 cm. Geschikt voor vrijhangende parasols.

		
500X500 mm	BC 5151G	60 kg



BV5050G

- Vaso in cemento grigio con maniglie. Per ombrelloni a braccio.
- Concrete grey cement pot with handles. For cantilever parasols.
- Grauer Betontopf mit Handgriffen. Fuer Pendelschirme.
- Vase ciment couleur gris avec poignées. Pour parasols avec bras deporté.
- Maceta de cemento gris con asas. Para parasoles con voladizo.
- Plantenschaal grijs beton met handgrepen. Geschikt voor vrijhangende parasols.

			
500x500	BV5050G	270 mm	80 kg



BV5050B

- Vaso in cemento bianco con maniglie. Per ombrelloni a braccio.
- Concrete white cement pot with handles. For cantilever parasols
- Weisser Betontopf mit Handgriffen. Fuer Pendelschirme.
- Vase ciment couleur blanc avec poignées. Pour parasols avec bras deporté
- Maceta de cerámica con asas de hormigón. Para parasoles con voladizo.
- Plantenschaal beton met handgrepen. Geschikt voor vrijhangende parasols.

			
500x500	BV5050B	270 mm	80 kg

30. Palladio Standard

I

Telaio in legno Iroko selezionato, trattato con vernice protettiva per esterni.

F

Armature: Bois Iroko sélectionné, traité avec un vernis protecteur.

UK

Frame: Selected Iroko wood. Varnished and treated.

E

Estructura: Iroko con recubrimientos protectores para uso en exteriores.

D

Gestell: Erstklassiges Irokoholz mit umweltfreundlicher Schutzlasur.

NL

Mast en baleinen: Iroko. Milieuvriendelijk behandeld.

↑ ↔	COD	MEASURES		CHARACTERISTICS							
		KG	M ³								
	2,5 C2500 PAS	 2500	 2250 2650	10	0,09	38	-	IROKO WOOD	6	IROKO WOOD	18x30
	3,0 C3000 PAS	 3000	 2300 2800	17	0,10	48	-	IROKO WOOD	8	IROKO WOOD	18x34
	3,5 C3500 PAS	 3500	 2300 2800	18	0,10	48	-	IROKO WOOD	8	IROKO WOOD	18x34
	4,0 C4000 PAS	 4000	 2500 3000	23	0,17	58	-	IROKO WOOD	8	IROKO WOOD	18x34
	3,0x3,0 C3030 PAS	 3000 3000	 2100 2800	20	0,11	48	-	IROKO WOOD	8	IROKO WOOD	18x34
	3,5x3,5 C3535 PAS	 3500 3500	 2150 3000	25	0,17	58	-	IROKO WOOD	8	IROKO WOOD	18x34
	4,0x4,0 C4040 PAS	 4000 4000	 2200 3300	31	0,17	58	-	IROKO WOOD	8	IROKO WOOD	20x34
	2,0x3,0 C2030 PAS	 3000 2000	 2100 2800	16	0,14	48	-	IROKO WOOD	8	IROKO WOOD	18x34
	3,0x4,0 C3040 PAS	 4000 3000	 2150 3000	26	0,12	58	-	IROKO WOOD	8	IROKO WOOD	18x34

FINISHING				COLOUR RANGE									OPTIONAL			BASES									
				ACRYL 350 GR										GOLD		BC35	BC55 BC55M	BC80M	BF6565D BF6565Z	BF6666D	BLZ	BTT55+BTC BTT65+BTC			
				A1	A1	A2	A3	A6	A7	S1	P2														
●	●	-	-	-		-	-	-	-	-	-				●	●	●			/	/	/	/		
●	●	-	-	-		-	-	-	-	-	-				●	●	●			/	/	/	/		
●	●	-	-	-							-				●	●	●	/			/	/	/		
●	●	-	-	-		-	-	-	-	-	-				●	●	●	/							
●	●	-	●												●	●	●	/							
●	●	-	●								-				●	●	●	/							
●	●	-	●								-				●	●	●	/	/		/				
●	●	-	●		-	-	-	-	-	-	-				●	●	●					/	/		
●	●	-	●												●	●	●	/							

26. Milano Standard

I
Telaio: Palo in alluminio verniciato a polveri colore bianco. Stecche in legno frassino sbiancato.

F
Armature: Mat en aluminium vernis blanc. Baleines bois frenes bianchi.

UK
Frame: Aluminium pole, powder coated white. Ribs in blenched ash wood.

E
Estructura: mástil de aluminio recubierto de polvo de color blanco. Varillas de madera de fresno. Accesorios de nylon blanco.

D
Gestell: Mast aus pulverbeschichtetem Aluminium Farbe weiss. Streben aus ausgebleichtem Eschenholz.

NL
Mast: aluminium, wit geëpoxeerd. Baleinen transparant wit gelakt essen.

↑	COD	MEASURES		CHARACTERISTICS							
		KG	M ³	↓	↑	↑	↑	↑	↑	↑	
3,0x3,0	C3030 MIS	19	0,11	55	-	ALU WHITE	8	ASH WOOD	18x34		
3,5x3,5	C3535 MIS	22	0,12	55	-	ALU WHITE	8	ASH WOOD	18x34		
3,0x4,0	C3040 MIS	22	0,12	55	-	ALU WHITE	8	ASH WOOD	18x34		

28. Napoli Standard

I
Telaio in alluminio verniciato a polveri colore antracite.

F
Armature: Aluminium vernis couleur gris anthracite.

UK
Frame: aluminium powder coated anthracite grey.

E
Polvo de aluminio recubierto marco de antracita. Accesorios de nylon.

D
Gestell: Pulverbeschichtetes Aluminium Farbe Anthrazitgrau.

NL
Mast en baleinen: aluminium, antracietgrijs geëpoxeerd.

↑	COD	MEASURES		CHARACTERISTICS							
		KG	M ³	↓	↑	↑	↑	↑	↑	↑	
3,5	C3500 NAS	14	0,10	50	-	ALU DARK	8	ALU DARK	18x30		
3,0x3,0	C3030 NAS	15	0,11	50	-	ALU DARK	8	ALU DARK	18x30		
3,0x4,0	C3040 NA	18	0,12	50	-	ALU DARK	8	ALU DARK	18x30		

FINISHING				COLOUR RANGE							OPTIONAL			BASES						
				ACRYL 350 GR								GOLD		BC35	BC55 BC55M	BC80M	BF6565D BF6565Z	BF6666D	BLZ	BTT55+BTC BTT65+BTC
				A1	A1	A2	A3	A6	A7	S1										
•	•	•	•								•	-	•	/						
•	•	•	•								•	-	•	/						
•	•	•	•								•	-	•	/						

FINISHING				COLOUR RANGE								OPTIONAL			BASES						
				ACRYL 350 GR									GOLD		BC35	BC55 BC55M	BC80M	BF6565D BF6565Z	BF6666D	BLZ	BTT55+BTC BTT65+BTC
				A1	A1	A2	A3	A6	A7	S1	P2										
•	•	•	-	-							-	•	-	•	/			/	/	/	
•	•	•	•									•	-	•	/						
•	•	•	•									•	-	•	/						

34. Palladio Telescopic

<p>I Sistema di apertura telescopico. Telaio in legno Iroko selezionato, trattato con vernice protettiva per esterni.</p> <p>F Ouverture telescopique. Armature: Bois Iroko sélectionné, traité avec un vernis protecteur.</p>	<p>UK Telescopic opening system. Frame: Selected Iroko wood. Varnished and treated.</p> <p>E Sistema de apertura telescópica. Estructura: Iroko con recubrimientos protectores para uso en exteriores.</p>	<p>D Teleskopoeffnungssystem. Gestell: Erstklassiges Irokoholz mit umweltfreundlicher Schutzlasur.</p> <p>NL Telescoop systeem voor het openen en sluiten van de parasol boven de tafel. Mast en baleinen: Iroko, milieuvriendelijk behandeld.</p>
--	--	--

COD		MEASURES				CHARACTERISTICS						
↑	→	KG	M ³	☼	☰	🌳	☀️	📦	📏			
5,0	C5000 PAT	32	0,21	58	-	IROKO WOOD	10	IROKO WOOD	18x34			
4,0x4,0	C4040 PAT	30	0,23	58	-	IROKO WOOD	8	IROKO WOOD	20x34			
3,0x4,0	C3040 PAT	25	0,15	58	-	IROKO WOOD	8	IROKO WOOD	18x34			

32. Leonardo Telescopic

<p>I Sistema di apertura telescopico. Telaio: Alluminio verniciato a polveri colore antracite.</p> <p>F Ouverture telescopique. Armature: Aluminium vernis couleur gris anthracite.</p>	<p>UK Telescopic opening system. Frame: Aluminium powder coated anthracite grey.</p> <p>E Sistema de apertura telescópica. Mástil: aluminio recubierto de color antracita. Accesorios de nylon.</p>	<p>D Teleskopoeffnungssystem. Gestell: Pulverbeschichtetes Aluminium Farbe Anthrazitgrau.</p> <p>NL Telescoop systeem voor het openen en sluiten van de parasol boven de tafel. Mast en baleinen: aluminium, antracietgrijs geëpoxeerd.</p>
---	---	---

COD		MEASURES				CHARACTERISTICS						
↑	→	KG	M ³	☼	☰	🌳	☀️	📦	📏			
4,0x4,0	C4040 LET	25	0,20	55	-	ALU DARK	8	ALU DARK	18x35			

36. Capri

<p>I Ombrellone gigante. Telaio con sistema di apertura telescopico in alluminio, componenti in acciaio verniciato a polveri colore antracite.</p> <p>F Parasol géant. Ouverture telescopique. Armature : Aluminium, composants en acier vernis couleur gris anthracite.</p>	<p>UK Giant parasol. Telescopic opening system. Frame: powder coated aluminium, steel components anthracite grey.</p> <p>E Parasol gigante con sistema de apertura telescópica. Herrajes: aluminio, componentes en acero color gris antracita.</p>	<p>D Riesenschirm. Teleskopoeffnungssystem. Gestell: Pulverbeschichtetes Aluminium Farbe Anthrazitgrau, Bestandteile aus Stahl.</p> <p>NL Maxi parasol: Telescoop systeem, voor het openen en sluiten van de parasol boven de tafel. Mast en baleinen: Grijs geëpoxeerd aluminium en staal.</p>
--	--	---

COD		MEASURES				CHARACTERISTICS						
↑	→	KG	M ³	☼	☰	🌳	☀️	📦	📏			
5,0x5,0	C5050 CAT	130	0,80	100	-	ALU DARK	8	ALU DARK	20x40			
6,0x6,0	C6060 CAT	150	0,90	100	-	ALU DARK	8	ALU DARK	20x40			

FINISHING					COLOUR RANGE							OPTIONAL			BASES						
					ACRYL 350 GR								GOLD		BC35	BC55 BC55M	BC80M	BF6565D BF6565Z	BF6666D	BLZ	BTT55+BTC BTT65+BTC
					A1	A1	A2	A3	A6	A7	S1		GOLD								
•	•	-	•	-	-		-	-	-	-	-	•	•	•	/	/		/			
•	•	-	•	•								•	•	•	/	/		/			
•	•	-	•	•								•	•	•	/						

FINISHING					COLOUR RANGE							OPTIONAL			BASES						
					ACRYL 350 GR								GOLD		BC35	BC55 BC55M	BC80M	BF6565D BF6565Z	BF6666D	BLZ	BTT55+BTC BTT65+BTC
				•	A1S	A1N	A2S	A3S	A6N	A7N	S1N	•	-	•	/	/		/			
•	•	•	•	•								•	-	•	/	/		/			

FINISHING						COLOUR RANGE		OPTIONAL	BASES					
				INOX		ACRYL 350 GR			N°2 BC5151 N°6 BC5050	N°4 BC5151 N°12 BC5050	N°2 BV5050	N°4 BV5050	FISSAGGIO TERRA INGROUND FIX	
						A1S	A1N		/		/			
•	•	•	•	•	•			•	/		/			
•	•	•	•	•	•			•	/		/			

16. Leonardo Braccio

I

Ombrellone a braccio laterale robusto. Telaio: Alluminio e componenti in acciaio; verniciato a polveri colore antracite. Accessori in nylon.

F

Parasol bras deporté robuste. Armature: Aluminium vernis couleur gris anthracite. Accessoires en nylon.

UK

Strong cantilever parasol. Frame: Powder coated aluminium anthracite grey. Nylon accessories.

E

Brazo lateral resistente. Estructura: aluminio y piezas de acero, recubierto con polvo de antracita. Accesorios de nylon.

D

Starker Pendelschirm. Gestell aus pulverbeschichtetem Aluminium Farbe Anthrazitgrau. Zubehoer aus Nylon.

NL

Robuuste vrijhangende parasol. Mast en baleinen: grijs geëpoxeerd aluminium en staal.

↑	COD	MEASURES		CHARACTERISTICS						
		Top View	Side View	KG	M ³	Canopy	Material	Wind	Accessories	Dimensions
	4,0 C4000 LEB			68	0,35	92x92	ALU DARK	8	ALU DARK	18x30
	3,0x3,0 C3030 LEB			68	0,35	92x92	ALU DARK	8	ALU DARK	18x30
	3,5x3,5 C3535 LEB			70	0,36	92x92	ALU DARK	8	ALU DARK	18x30
	4,0x4,0 C4040 LEB			100	0,48	92x92	ALU DARK	8	ALU DARK	18x35
	3,0x4,0 C3040 LEB			70	0,36	92x92	ALU DARK	8	ALU DARK	18x30

20. Napoli Braccio

I

Ombrellone a braccio laterale. Telaio in alluminio e componenti in acciaio; verniciato a polveri colore antracite. Accessori in nylon.

F

Parasol bras deporté. Armature en aluminium vernis, composants en acier couleur gris anthracite. Accessoires en nylon.

UK

Cantilever parasol. Frame in coated aluminium and steel components epoxy lacquered anthracite grey. Accessories made of nylon.

E

Parasol de brazo lateral. Herraje: aluminio y componentes de acero, recubierto con polvo de antracita. Accesorios de nylon.

D

Pendelschirm. Gestell aus pulverbeschichtetem Aluminium und Bestandteile aus Stahl Farbe Anthrazitgrau. Zubehoer aus Nylon.

NL

Vrijhangende parasol. Mast en baleinen: grijs geëpoxeerd aluminium en staal.

	3,0x3,0 C3030 NAB			50	0,20	75x75	ALU DARK	8	ALU DARK	18x30
	C2030 NAB			48	0,20	75x75	ALU DARK	8	ALU DARK	18x30
	2,0x3,0 NEW C3020 NAB									
	3,0x4,0 C3040 NAB			52	0,21	75x75	ALU DARK	8	ALU DARK	18x30

FINISHING								COLOUR RANGE								OPTIONAL		BASES						
								ACRYL 350 GR										N°2 BC5151 N°6 BC5050	N°4 BC5151 N°12 BC5050	N°2 BV5050	N°4 BV5050	FISSAGGIO TERRA INGROUND FIX		
								A1	A1	A2	A3	A6	A7	S1										
•	•	•	•	•	•	•	•	•	-		-	-	-	-	-	•	•	/		/				BTB
•	•	•	•	•	•	•	•	•								•	•				/			BTB
•	•	•	•	•	•	•	•	•								•	•				/			BTB
•	•	•	•	•	•	•	•	•								•	•	/		/			BTB	
•	•	•	•	•	•	•	•	•								•	•				/			BTB
•	•	•	•	•	•	•	•	•									•	•					BTB	
•	•	•	•	•	•	•	•	•		-	-	-	-	-	-	-	•	•					BTB	
•	•	•	•	•	•	•	•	•									•	•					BTB	

10. Galileo Maxi 4x4 New

<p>I Ombrellone a braccio laterale con sistema di apertura e chiusura retrattile. Telaio: Alluminio e componenti in acciaio; verniciato a polveri colore antracite. Accessori in nylon.</p> <p>F Parasol bras deporté avec système retractile. Armature :Aluminium vernis couleur gris anthracite. Accessoires en nylon.</p>	<p>UK Cantilever parasol with retractable opening and closing. Frame: powder coated aluminium anthracite grey. Nylon accessories.</p> <p>E Parasol de brazo lateral con sistema con la apertura y cierre retráctil. Herraje: Aluminio y acero, recubierto con polvo de antracita. Accesorios de nylon.</p>	<p>D Pendelschirm mit einziehbarem Oeffnungssystem. Gestell: Pulverbeschichtetes Aluminium Farbe Anthrazitgrau. Zubehoer aus Nylon.</p> <p>NL Vrijhangende parasol. Frame: grijs geëpoxeerd aluminium en staal f. wit.</p>
--	--	--

4x4	COD	MEASURES		CHARACTERISTICS							
		Top View	Side View	KG	M ³	Icon 1	Icon 2	Icon 3	Icon 4	Icon 5	Icon 6
	DARK C4040 GDR			110	0,55	-	92x92	ALU DARK	8	ALU DARK	18x35

06/08. Galileo White/Dark

<p>I Ombrellone a braccio laterale con sistema di apertura e chiusura retrattile. Telaio: Alluminio e componenti in acciaio; verniciato a polveri colore antracite o bianco. Accessori in nylon.</p> <p>F Parasol bras deporté avec système retractile. Armature :Aluminium vernis couleur gris anthracite o blanche. Accessoires en nylon.</p>	<p>UK Cantilever parasol with retractable opening and closing. Frame: powder coated aluminium anthracite grey or white. Nylon accessories.</p> <p>E Parasol de brazo lateral con sistema con la apertura y cierre retráctil. Herraje: Aluminio y acero, recubierto con polvo de antracita/blanco. Accesorios de nylon.</p>	<p>D Pendelschirm mit einziehbarem Oeffnungssystem. Gestell: Pulverbeschichtetes Aluminium Farbe Anthrazitgrau / Weiss. Zubehoer aus Nylon.</p> <p>NL Vrijhangende parasol. Frame: grijs geëpoxeerd aluminium en staal f. wit.</p>
---	--	--

3,0x3,0 NEW	COD	MEASURES		CHARACTERISTICS							
		Top View	Side View	KG	M ³	Icon 1	Icon 2	Icon 3	Icon 4	Icon 5	Icon 6
	DARK C3030 GDR			65	0,45	-	82x82	ALU DARK	8	ALU DARK	18x30
3,5x3,5	DARK C3535 GDR			75	0,45	-	82x82	ALU DARK	8	ALU DARK	18x30
	WHITE C3535 GWR		ALU WHITE					ALU WHITE			
3,0x4,0	DARK C3040 GDR			75	0,45	-	82x82	ALU DARK	8	ALU DARK	18x30
	WHITE C3040 GWR		ALU WHITE					ALU WHITE			

FINISHING								COLOUR RANGE							OPTIONAL		BASES				
						INOX			ACRYL 350 GR									N°2 BC5151 N°6 BC5050	N°4 BC5151 N°12 BC5050	N°4 BV5050	FISSAGGIO TERRA INGROUND FIX
•	•	•	•	•	•	•	•	•								•	•	/			

FINISHING								COLOUR RANGE							OPTIONAL		BASES				
						INOX			ACRYL 350 GR									N°2 BC5151 N°6 BC5050	N°4 BC5151 N°12 BC5050	N°4 BV5050	FISSAGGIO TERRA INGROUND FIX
•	•	•	•	•	•	•	•	•								•	•	/			
•	•	•	•	•	•	•	•	•								•	•	/			
•	•	•	•	•	•	•	•	•								•	•	/			

12. Giotto Braccio

I
Ombrellone a braccio laterale robusto. Telaio in alluminio e componenti in acciaio colore inox. Sostegno rivestito con finitura tabacco anticato.

F
Parasol bras déporté de belle qualité. Armature en aluminium avec composants en acier. Mât avec finition effet bois tabac antique.

UK
Strong cantilever parasol Aluminium. Frame with steel components. Support with finishing tobacco antique.

E
Parasol con brazo lateral robusto. Herrajes en aluminio y componentes en acero color inox. Soporte con acabado Tobacco antique.

D
Starker Pendelschirm. Gestell aus Aluminium mit Stahlbestandteile Farbe Edelstahl. Mast mit neuer Holzeffekt-Ausführung Antique Tobacco.

NL
Solide vrijhangende parasol. Aluminium frame met metalen delen met roestvrij staal-look Aluminium mast met hout-look. Kleur antique tobacco.

MEASURES	CHARACTERISTICS							
	KG	M ³						
3,5x3,5 C3535 GIB	70	0,36	-	92x92	ALU TOBACCO	8	INOX	18x30
3,0x4,0 C3040 GIB	70	0,36	-	92x92	ALU TOBACCO	8	INOX	18x30

14. Milano Braccio New

I
Ombrellone a braccio laterale robusto. Nuovo sostegno in alluminio con finitura in frassino sbiancato, stecche in legno frassino, componenti in alluminio e acciaio verniciato a polveri colore bianco.

F
Parasol à bras latra robuste. Nouveau mat en aluminium finition avec finition effet bois de frêne, baleines en bois de frêne, composants en aluminium et en acier laqué blanc.

UK
Strong cantilever parasol. New aluminium support provided with special bleached ash wood finishing, bleached ash wood ribs. Aluminium and steel components, epoxy coated colour white.

E
El parasol brazo lateral es robusto, con nuevo soporte en aluminio y acabado imitacion madera color fresno blanqueada. Varillas de madera de fresno y componentes en aluminio y acero pintados en polvo color blanco.

D
Starker Pendelschirm. Neuer Alumast mit speziellem, ausgebleichtem Eschenholz Effekt, Streben aus ausgebleichtem Eschenholz, Alu und Stahl Bestandteile pulverbeschichtet, Farbe weiß.

NL
Robuust vrijhangende parasol: Mast en baleinen: transparant wit gelakt essen.

3,5x3,5 C3535 MIB	80	0,36	-	92x92	ALU ASH / WHITE	8	ASH WOOD	18x34
3,0x4,0 C3040 MIB	80	0,36	-	92x92	ALU ASH / WHITE	8	ASH WOOD	18x34

18. Palladio Braccio New

I
Ombrellone a braccio laterale robusto. Nuovo sostegno in alluminio con finitura in legno, stecche in legno Iroko, componenti in alluminio e acciaio verniciato a polveri colore antracite. Accessori in nylon.

F
Parasol à bras latra robuste. Nouveau mat en aluminium finition avec finition effet bois de frêne, baleines en bois de frêne, composants en aluminium et en acier laqué blanc.

UK
Strong cantilever parasol. New aluminium support provided with special bleached ash wood finishing, bleached ash wood ribs, aluminium components, epoxy coated colour white.

E
El parasol brazo lateral es robusto. Con nuevo soporte en aluminio con acabados imitación madera, varillas de madera de Iroko y componentes en aluminio y acero pintados en polvo color antracita. Accesorios en nylon.

D
Starker Pendelschirm. Neuer Alumast mit speziellem, ausgebleichtem Eschenholz Effekt, Streben aus ausgebleichtem Eschenholz, Alu und Stahl Bestandteile pulverbeschichtet, Farbe weiß.

NL
Robuust vrijhangende parasol: Mast en baleinen: Iroko. Milieuvriendelijk behandeld. Overige metalen delen: Grijs geëpoxeerd staal.

3,5 C3500 PAB	75	0,35	-	92x92	ALU IROKO / DARK	8	IROKO WOOD	18x34
3,0x3,0 C3030 PAB	75	0,35	-	92x92	ALU IROKO / DARK	8	IROKO WOOD	18x34
3,5x3,5 C3535 PAB	80	0,36	-	92x92	ALU IROKO / DARK	8	IROKO WOOD	18x34
3,0x4,0 C3040 PAB	80	0,36	-	92x92	ALU IROKO / DARK	8	IROKO WOOD	18x34

FINISHING								COLOUR RANGE							OPTIONAL			BASES				
						INOX			ACRYL 350 GR							GOLD			N°2 BC5151 N°6 BC5050	N°4 BC5151 N°12 BC5050	N°2 BV5050	FISSAGGIO TERRA INGROUND FIX
																-						
																-						
																-						
																-						

24. Torino Braccio

I
Ombrellone a braccio laterale.
Telaio: Legno Iroko, componenti in acciaio colore antracite, nuovo sostegno in alluminio con finitura color legno.

F
Parasol deporté.
Armature: Bois Iroko, Composants en acier couleur gris anthracite, nouveau mât en aluminium effet bois.

UK
Cantilever parasol.
Frame: Iroko wood, steel components colour anthracite grey, new aluminium support with wooden colour finishing.

E
Sombrilla de brazo lateral.
Armazón: madera de iroko, componentes de acero color antracita y nuevo soporte en aluminio con acabado color madera.

D
Pendelschirm.
Gestell: Iroko Holz, Stahlbestandteile Farbe Anthrazitgrau, neuer Alumast mit Holzeffekt.

NL
Vrijhangende parasol.
Frame: hout iroko; metalen delen antraciet grijs; nieuwe aluminium mast in hout-look.

↑	COD	MEASURES		CHARACTERISTICS						
		KG	M ³	Icon 1	Icon 2	Icon 3	Icon 4	Icon 5	Icon 6	
	3,5 C3500 T0B			50	0,20	75x75	ALU IROKO / DARK	8	IROKO WOOD	18x34
	3,0x3,0 C3030 T0B			50	0,20	75x75	ALU IROKO / DARK	8	IROKO WOOD	18x34
	2,0x3,0 C2030 T0B			48	0,20	75x75	ALU IROKO / DARK	8	IROKO WOOD	18x34
	C3020 T0B									
	3,0x4,0 C3040 T0B			55	0,21	75x75	ALU IROKO / DARK	8	IROKO WOOD	18x34

22. Rimini Braccio

I
Ombrellone a braccio laterale robusto.
Telaio: alluminio e componenti in acciaio; verniciato a polveri colore bianco. Accessori in nylon.

F
Parasol bras deporté robuste.
Armature en aluminium vernis, composants en acier couleur blanc. Accessoires en nylon.

UK
Strong cantilever parasol.
Frame: powder coated aluminium and steel components white. Nylon accessories.

E
Parasol con brazo lateral.
Estructura: aluminio y componentes de acero, recubierto con polvo color blanco. Accesorios de nylon.

D
Starker Pendelschirm. Gestell: Pulverbeschichtetes Aluminium und Bestandteile aus Stahl Farbe weiss. Zubehoer aus Nylon.

NL
Robuuste vrijhangende parasol.
Mast en baleinen: wit geëpoxeerd aluminium en staal.

↑	COD	MEASURES		CHARACTERISTICS						
		KG	M ³	Icon 1	Icon 2	Icon 3	Icon 4	Icon 5	Icon 6	
	3,0x3,0 C3030 RIB			50	0,20	75x75	ALU WHITE	8	ALU WHITE	18x30
	3,0x4,0 C3040 RIB			52	0,21	75x75	ALU WHITE	8	ALU WHITE	18x30

FINISHING									COLOUR RANGE								OPTIONAL		BASES			
						INOX			ACRYL 350 GR										N°2 BC5151 N°6 BC5050	N°4 BC5151 N°12 BC5050	N°2 BV5050	FISSAGGIO TERRA INGROUND FIX
									A1	A1	A2	A3	A6	A7	S1	P2						
•	•	•	•	•	•	•	•	•	-							-	•	•				
•	•	•	•	•	•	•	•	•									•	•				
•	•	•	•	•	•	•	•	•		-	-	-	-	-	-	-	•	•				
•	•	•	•	•	•	-	•	•									•	•				

FINISHING									COLOUR RANGE								OPTIONAL		BASES			
						INOX			ACRYL 350 GR										N°2 BC5151 N°6 BC5050	N°4 BC5151 N°12 BC5050	N°2 BV5050	FISSAGGIO TERRA INGROUND FIX
									A1	A1	A2	A3	A6	A7	S1	P2						
•	•	•	•	•	•	•	•	•									•	•				
•	•	•	•	•	•	•	•	•									•	•				

42. Wood Poker / Double

<p>I Struttura robusta composta da 4 ombrelloni (Poker) oppure da 2 ombrelloni (Double) a braccio laterale. Telaio in legno Iroko trattato con vernice protettiva, componenti in acciaio; verniciato a polveri colore antracite. Accessori in nylon.</p> <p>F Structure robuste avec 4 parasols (Poker) ou 2 parasols (Double). Armature: Bois Iroko traité avec un vernis protecteur, composants en acier couleur gris anthracite. Accessoires en nylon.</p>	<p>UK Strong structure made of 4 cantilever parasols (Poker) or 2 cantilever parasols (Double) Frame: Iroko wood varnished and treated. Steel components powder coated anthracite grey. Nylon accessories.</p> <p>E Estructura robusta que se compone de 4 parasoles (Poker) – 2 parasoles (Double) con brazo lateral. Herrajes: Madera Irokoy acero color gris antracita. Accesorios de nylon.</p>	<p>D Starke Struktur mit 4 Pendelschirmen (Poker) oder 2 Pendelschirmen (Double). Gestell: Irokoholz mit Schutzlasur, Bestandteile aus Stahl Farbe Anthrazitgrau. Zubehoer aus Nylon.</p> <p>NL Zware mast met 4 (Poker) – 2 (Double) vrijhangende parasols: Mast en baleinen: Iroko. Milieuvriendelijk behandeld. Overige metalen delen: Grijs geëpoxeerd staal.</p>
---	---	---

↑ ↓	COD	MEASURES		CHARACTERISTICS					
		KG	M ³	Icon 1	Icon 2	Icon 3	Icon 4	Icon 5	Icon 6
	6,0x6,0 C6060 WPO	185	1,10	120x120	IROKO WOOD / DARK	IROKO WOOD	18x34		
	7,0x7,0 C7070 WPO	200	1,10	120x120	IROKO WOOD / DARK	IROKO WOOD	18x34		
	3,0x6,0 C3060 WDO	115	0,90	120x120	IROKO WOOD / DARK	IROKO WOOD	18x34		
	3,5x7,0 C3570 WDO	130	0,90	120x120	IROKO WOOD / DARK	IROKO WOOD	18x34		

38. Milano Poker / Double New

<p>I Struttura robusta composta da 4 ombrelloni (Poker) oppure da 2 ombrelloni (Double) a braccio laterale. Nuovo sostegno in alluminio con finitura in frassino sbiancato, stecche in legno frassino, componenti in alluminio e acciaio verniciato a polveri colore bianco. Accessori in nylon.</p> <p>F Structure robuste avec 4 parasols (Poker) ou 2 parasols (Double). Armature: Nouveau mat en aluminium finition bois de frêne, baleines de bois de frêne, composants en aluminium et en acier laqué blanc. Accessoires en nylon.</p>	<p>UK Strong structure made of 4 cantilever parasols (Poker) or 2 cantilever parasols (Double) Frame: New aluminium support provided with special bleached ash wood finishing, bleached ash wood ribs, aluminium and steel components white epoxy lacquered. Nylon accessories.</p> <p>E Estructura robusta que se compone de 4 parasoles (Poker) – 2 parasoles (Double) con brazo lateral. Nuevo soporte en aluminio con acabados color freno blanqueada, y componentes en aluminio y acero pintados en polvo color blanco. Accesorios de nylon.</p>	<p>D Starke Struktur mit 4 Pendelschirmen (Poker) oder 2 Pendelschirmen (Double). Neuer Alumast mit speziellem Eschenholzeffekt, Streben aus ausgebleichtem Eschenholz, Alu und Stahl Bestandteile weiss pulverbeschichtet. Zubehoer aus Nylon.</p> <p>NL Zware mast met 4 (Poker) – 2 (Double) vrijhangende parasols. Nu met nieuwe aluminium mast met uniek essenhouten uitstraling, baleinen in wit essenhout. Aluminium en metalen delen zijn wit geëpoxeerd.</p>
--	---	---

	6,0x6,0 C6060 MPO	185	1,10	120x120	ALU ASH / WHITE	ASH WOOD	18x34		
	7,0x7,0 C7070 MPO	200	1,10	120x120	ALU ASH / WHITE	ASH WOOD	18x34		
	3,0x6,0 C3060 MDO	115	0,90	120x120	ALU ASH / WHITE	ASH WOOD	18x34		
	3,5x7,0 C3570 MDO	130	0,90	120x120	ALU ASH / WHITE	ASH WOOD	18x34		

FINISHING						COLOUR RANGE							OPTIONAL				BASES				
					INOX	ACRYL 350 GR								GOLD			N°2 BC5151	N°4 BC5151	N°2 BV5050	N°4 BV5050	FISSAGGIO TERRA
						A1	A1	A2	A3	A6	A7	S1					N°6 BC5050	N°12 BC5050			INGROUND FIX
•	•	•	•	•	•								•	•	•	•	/		/		
•	•	•	•	•	•								•	•	•	•	/		/		
•	•	•	•	•	•								•	•	•	•	/		/		
•	•	•	•	•	•								•	•	•	•	/		/		
•	•	•	•	•	•								•	-	•	•	/		/		
•	•	•	•	•	•								•	-	•	•	/		/		
•	•	•	•	•	•								•	-	•	•	/		/		

40. Alu Poker / Double

I

Struttura robusta composta da 4 ombrelloni (Poker) oppure da 2 ombrelloni (Double). Telaio in alluminio e componenti in acciaio; verniciato a polveri colore antracite. Accessori in nylon.

F

Structure robuste avec 4 parasols (Poker) ou 2 parasols (Double). Armature en aluminium vernis, composants en acier couleur gris anthracite. Accessoires en nylon.

UK

Strong structure made of 4 cantilever parasols (Poker) or 2 cantilever parasols (Double). Frame in coated aluminium and steel components powder coated anthracite grey. Accessories made of nylon.

E







Estructura robusta que se compone de 4 parasoles (Poker) – 2 parasoles (Double). Herrajes: Aluminio y acero color gris antracita. Accesorios de nylon.

D

Starke Struktur mit 4 Pendelschirmen (Poker) oder 2 Pendelschirmen (Double). Gestell aus pulverbeschichtetem Aluminium und Bestandteile aus Stahl Farbe Anthrazitgrau. Zubehoer aus Nylon.

NL

Zware mast met 4 (Poker) – 2 (Double) vrijhangende parasols: Mast en baleinen: Grijs geëpoxeerd aluminium. Overige metalen delen: Grijs geëpoxeerd staal.

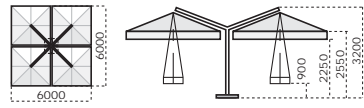
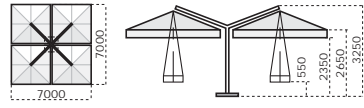
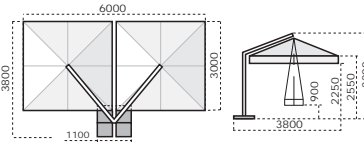
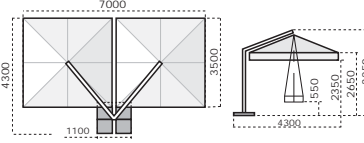
	 COD	MEASURES		CHARACTERISTICS					
		KG	M ²						
6,0x6,0	C6060 APO	170	1,00	120x120	ALU DARK	ALU DARK	18x30		
7,0x7,0	C7070 APO	185	1,00	120x120	ALU DARK	ALU DARK	18x30		
3,0x6,0	C3060 ADO	100	0,80	120x120	ALU DARK	ALU DARK	18x30		
3,5x7,0	C3570 ADO	110	0,80	120x120	ALU DARK	ALU DARK	18x30		

04. Vela Sail-Parasol New

I

Telaio in alluminio anodizzato argento. Viteria in acciaio e componenti in nylon colore bianco.

F

Cadre en aluminium anodisé argent. Visserie en acier et composants en nylon blanc.

UK

Silver anodized aluminum frame. Steel screws and components in white nylon.

E







Estructura de aluminio anodizado color plata, tornillos de acero y componentes de nylon blanco.

D

Silber eloxiertes Aluminium Gestell. Stahlschrauben und Zubehoer aus weißem Nylon.

NL

Het frame is zilverkleurig geëloxeerd met stalen schroeven. Overige bewegende delen zijn van nylon.

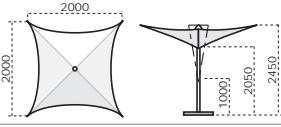
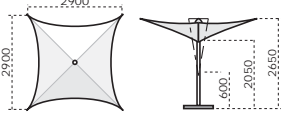
	 COD	MEASURES		CHARACTERISTICS					
		KG	M ²						
2,0x2,0	C2020 VSP	11	0,10	50	ALU ANODIZED	4	ALU ANODIZED	18x30	
3,0x3,0	C3030 VSP	14	0,10	50	ALU ANODIZED	4	ALU ANODIZED	18x30	

FINISHING						COLOUR RANGE							OPTIONAL				BASES				
					INOX	ACRYL 350 GR								GOLD			N°2 BC5151 N°6 BC5050	N°4 BC5151 N°12 BC5050	N°2 BV5050	N°4 BV5050	FISSAGGIO TERRA INGROUND FIX
						A1	A1	A2	A3	A6	A7	S1									
•	•	•	•	•	•								•	-	•	•	/		/		
•	•	•	•	•	•								•	-	•	•	/		/		
•	•	•	•	•	•								•	-	•	•	/		/		
•	•	•	•	•	•								•	-	•	•	/		/		

FINISHING		COLOUR RANGE		OPTIONAL		BASES						
		ACRYL 350 GR				BC35	BC55 BC55M	BC80M	BF6565D BF6565Z	BF6666D	BLZ	BTT55+BTC BTT65+BTC
		A6	A7									
•	•			•	•					/	/	
•	•			•	•	/					/	

Materiali e finiture Materials and finishing

Componenti e profili alluminio Aluminium components and profiles



DARK



WHITE



INOX COLOUR



ANODIZED



TOBACCO



ALUMINIUM IROKO



ALUMINIUM
ASH - FRASSINO

Componenti e stecche legno Wooden components and ribs



IROKO WOOD



ASH WOOD
LEGNO FRASSINO

Gamma colori Colours range

350 gr/m²

ACRYLIC



A1
ECRU
NATURAL COL.
NATUR



A2
TERRACOTTA
ZIEGELROT
TERRACOTTA



A3
BORDEAUX



A6
GRIGIO TAUPE
GREY TAUPE
GRAU TAUPE
GRIS TAUPE
GRIJS TAUPE

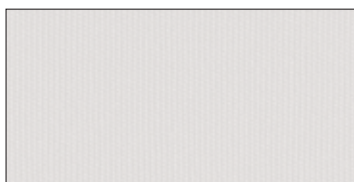

A7
BIANCO
WHITE
BLANC
WEISS



S1
NERO
BLACK
SCHWARZ
NOIRE
NEGRO
ZWART

250 gr/m²

POLYESTER



P2
ECRU
NATURAL COL.
NATUR

Cura dei particolari Finishing care



Galileo



Braccio

New System

PATENTED



I Per tutti gli ombrelloni a braccio vengono introdotte le nuove corone centrali in plastica. Il nuovo sistema è stato studiato da Scolaro per aumentare la resistenza e durata, semplificare la manutenzione e migliorare il design. Inoltre è previsto l'aggancio singolo per ogni stecca che ne rende l'eventuale sostituzione semplice, veloce e alla portata dell'utente finale.

UK For all cantilever parasols new plastic crowns will be employed. The new system studied by Scolaro increases the resistance and long lasting, simplifies the maintenance and improves the design. Furthermore each rib is fixed separately. This makes the replacement easy, quick and within everybody's reach.

D Fuer alle Pendelschirme hat die Firma Scolaro neue Plastikkronen entwickelt. Dieses neue System steigert die Widerstandsfähigkeit und die Dauer, erleichtert die Wartung und verbessert das Design. Alle Streben sind einzeln befestigt. Der Ersatz ist dadurch sehr leicht, schnell und auch seitens des Endverbrauchers ausfuehrbar.

F Pour tous les parasols avec bras deporté la société Scolaro a développé des nouvelles couronnes en plastique. Ce nouveau système augmente la résistance et la durée, simplifie l'entretien et améliore le design. Toutes les baleines sont accrochées individuellement. Le remplacement est très facile, rapide et à la portée de l'utilisateur final.

NL Voor alle zwevende parasols heeft Scolaro een nieuwe kunststof kroon ontwikkeld. Dit nieuwe systeem verhoogt niet alleen de functionaliteit en de duurzaamheid maar vereenvoudigt tevens het gebruik en verfraait de vormgeving. In deze kroon is iedere balein individueel bevestigd. Het vervangen van een balein is daardoor uitermate gemakkelijk, snel en voor iedereen te doen.

Sole Light



I Nuova lampada per ombrellone wireless con luminosità potenziata del doppio. Colore Nero. Si adatta a tutti gli ombrelloni con palo da 27 a 50 mm. Adatta anche per ombrelloni a braccio. Illuminazione a LED. Ricaricabile come un cellulare: 2 ore di ricarica – circa 6 di luce. Fissaggio con illuminazione verso il basso e verso l'alto. Carica batterie incluso. Incluso adattatore per ombrelloni a braccio Scolaro.

UK New battery rechargeable light for parasols with increased brightness twice than the previous version. Colour black. Suitable for parasols with pole diameter from 27 to 50mm. LED lights. Rechargeable: 2 hours recharging – 6 hours light. Down- and up light. AC Adapter included. Adaptation accessory for Scolaro's cantilever parasols included.

D Neue batteriebetriebene/wireless Beleuchtung fuer Schirme mit gesteigerter Lichtstaerke. Farbe schwarz. Eignet sich fuer alle Schirme. Ab Mastdurchmesser 27 bis 50mm. Auch fuer Pendelschirme geeignet LED Beleuchtung. Wiederaufladbar: 2 Stunden Wiederladung – 6 Stunden Beleuchtung. Beleuchtung nach oben oder nach unten moeglich. Aufladegeraet inbegriffen. Anpassungsteil fuer die Befestigung an Scolaro Seitenarmschirme inbegriffen.

F Nouveau éclairage pour parasols avec luminosité potencé. Couleur noir. Fonctionnement par batterie incorporée. Compatible sur mât de 27mm à 50mm. Possible sur parasol avec bras éxcentré. Éclairage LED. Rechargeable en 2 heures pour 6 heures d'autonomie. Éclairage orientable. Chargeur inclus.

E la primera lampara wireless por sombrilla, que se adapta a todos los sombrillas con palo desde 27 a 50 mm. Apta tambien para sombrillas a brazo. Iluminacion LED. Recargable como un mobil. 2 horas de carga-cerca de 6 horas de luz. Se puede fijar con la iluminacion en direccion del suelo o del cielo. El carga bateria está incluido.

NL Snoerloze PARSOLVERLICHTING Geen probleem meer met losse snoeren. Deze snoerloze parasolverlichting past op alle ronde parasolbuizen met een diameter tussen de 27 mm. en 50 mm. en kan zowel naar boven als naar beneden gericht worden. Ook geschikt voor het gebruik op de zwevende parasols uit het Scolaro sortiment. Eenvoudig te bevestigen dankzij een verend klemmechanisme. Het bijpassende oplaadapparaat (110V / 220V) wordt meegeleverd.







	BASES					FISSAGGIO A TERRA INGROUND FIX
	N° 2 BC5151 N° 6 BC5050	N° 4 BC5151 N° 12 BC5050	N° 2 BV5050	N° 4 BV5050		
Ø 3,5				/		BTB
Ø 4,0	/		/			BTB
3,0 x 3,0				/		BTB
3,5 x 3,5				/		BTB
4,0 x 4,0	/		/			BTB
2,0 x 3,0				/		BTB
3,0 x 4,0				/		BTB
3,0 x 3,0 Galileo	/			/		BTB
3,5 x 3,5 Galileo	/			/		BTB
4,0 x 4,0 Galileo	/		/			BTB
3,0 x 4,0 Galileo	/			/		BTB
5,0 x 5,0 Capri	/		/			
6,0 x 6,0 Capri	/		/			
3,0 x 6,0 Double	/		/			
3,5 x 7,0 Double	/		/			
6,0 x 6,0 Poker	/		/			
7,0 x 7,0 Poker	/		/			

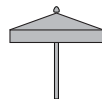

	BASES						
	BC35	BC55 BC55M	BC80M	BF6565D BF6565Z	BF6666D	BLZ	BTT55 + BTC BTT65 + BTC
Ø 2,5			/	/	/	/	
Ø 3,0				/	/	/	
Ø 3,5	/			/	/	/	
Ø 4,0	/						
Ø 5,0	/	/		/			
3,0 x 3,0	/						
3,5 x 3,5	/						
4,0 x 4,0	/	/		/			
2,0 x 3,0					/	/	
3,0 x 4,0	/						

I

Queste tabelle sono indicative e prevedono che il pavimento o il terreno di appoggio sia perfettamente piano e regolare. Gli ombrelloni e i rispettivi componenti delle basi devono essere assemblati correttamente rispettando le istruzioni di montaggio. La stabilità degli ombrelloni può variare nel caso di condizioni atmosferiche particolari. L'utilizzatore finale è responsabile del corretto uso dell'ombrellone. Nessuna rivalsa può essere fatta sul produttore.

UK

This schedule considers statics calculation and foresees that the floor where the parasol has to be positioned is perfectly flat and regular. The parasols and components have to be assembled correctly and respecting the assembly instruction. The schedule has to be considered indicative because many variables that depend from the area of employ and position of the parasols are not foreseeable. No rights can be derived from this. The use of a parasol is always on your own responsibility.

D

Diese Aufstellung beinhaltet statistische Kalkulationen und sieht vor, dass der Schirm auf einem ebenen und regelmaessigen Boden positioniert wird. Der Schirm und die Bestandteile des Staenders muessen genaess Anbauanleitungen montiert werden. Die Stabilitaet der Schirme kann auf Grund besonderer klimatischen Konditionen aendern. Der Endbenutzer ist fuer die ordnungsgemaesse Verwendung des Schirmes verantwortlich.

F

Ces tableaux sont à titre indicatif et ils prévoient que la surface sur laquelle est implanté le parasol soit parfaitement plane et lisse. Les parasols et les éléments respectifs des bases doivent être assemblés en respectant scrupuleusement les instructions de montage. La stabilité des parasols peut varier dans le cas de conditions atmosphériques particulières et dépend du lieu et de l'utilisation propre à chaque utilisateur (le parasol doit être fermé en cas de vent fort et/ou de mauvaises conditions météorologiques).

E

Estos cuadros son indicativos y requieren que el suelo o el apoyo de tierra sea perfectamente plano y liso. El parasol y los respectivos componentes de la base deben ser montados correctamente respetando las instrucciones. La estabilidad de los parasoles puede variar según las condiciones atmosféricas.

NL

This schedule considers statics calculation and foresees that the floor where the parasol has to be positioned is perfectly flat and regular. The parasols and components have to be assembled correctly and respecting the assembly instruction. The schedule has to be considered indicative because many variables that depend from the area of employ and position of the parasols are not foreseeable.



SCOLARO Mario & Fabio srl

Via Liguria, 197 - 35040 Casale di Scodosia (PD) - ITALY - TEL. +39 0429 656687 - FAX. +39 0429 657874

info@scolaro-parasol.it - www.scolaro-parasol.it

Le informazioni contenute in questo catalogo o in altri stampati pubblicitari della ditta Scolaro, quali caratteristiche tecniche dei prodotti o dei componenti, dimensioni, schemi di montaggio, colori, ecc., hanno valore meramente indicativo, in ragione delle specifiche tecniche e della evoluzione tecnologica dei prodotti aziendali. Al fine di migliorare la qualità del prodotto, la ditta si riserva il diritto di modificare lo stesso senza alcun preavviso e anche dopo l'accettazione dell'ordine. L'azienda si riserva di apportare modifiche parziali o totali ai prodotti senza preavviso declinando ogni responsabilità su eventuali dati inesatti. Eventuali lievi variazioni di tonalità dei colori e delle finiture rientrano nelle normali caratteristiche dei materiali impiegati. Tutte le differenze sopraindicate non sono tali da modificare significativamente i prodotti stessi e non costituiscono motivo di reso o sostituzione della merce o di contestazione.

The information contained in this brochures or other Scolaro's advertisements prints , such as product specifications or components, dimensions, assembling instruction, colours, etc., are purely indicative, because of the technical specifications and the technological evolution of the company's products. In order to improve the quality of the product, the company reserves the right to change the same without prior notice and even after acceptance of the order. The company reserves the right to make partial or complete changes to the products without prior notice and declines any responsibility for inaccurate data. Any colour differences and changes of finishing have to be considered normal characteristics of the materials used. These differences do not significantly change the products and aren't reason for return or replacement of the goods or dispute.